

MONTAGEANLEITUNG / SERVICEKARTE

MONTAGEANLEITUNG SOLLTE NICHT ALS TECHNISCHE DOKUMENTATION BETRACHTET WERDEN. AUFBAUANDEUTUNGEN VOM PRODUZENTEN VORBEHALTEN

SEHR GEEHTER KUNDE, SOLLTE EIN TEIL FAHLEN ODER BESCHADIGT SEIN, KREUZEN SIE BITTE DIESES DEUTLICH AUF DER SERVICEKARD AN UND SCHICKEN SIE UNS DIE SERVICEKARD ZURÜCK.

DEN KLEBER BENUTZEN SIE NUR ZUM VERLEIMEN DER SCHUBLADEN.

UM DIE EVENTUELLEN REKLAS RICHTIG ZU ERLEDIGEN, BITTEN WIR UM EINE KOPIE DES AUFKLEBERS VON DER WARE, ODER UM ANGABE DER PRODUKTIONSWOCHE.

TEILNUMMER	TEILBEZEICHNUNG	MENGE	ZEIT
①	864x350x16	1	2/2
②	864x350x16	1	2/2
③	864x350x16	1	2/2
④	804x350x16	1	2/2
⑤	736x350x16	1	1/2
⑥	736x350x16	1	1/2
⑦	1520x353x16	1	1/2
⑧	1521x60x16	1	1/2
⑨	1521x60x16	1	1/2
⑩	759x60x16	1	1/2
⑪	759x60x16	1	1/2
⑫	385x350x16	1	1/2
⑬	736x350x16	1	1/2
⑭	186x346x16	4	2/2
⑮	310x110x16	4	1/2
⑯	310x110x16	4	1/2
⑰	293x84x16	4	1/2
⑱	307x317x3	4	1/2
⑳	754x346x16	1	2/2
㉑	754x346x16	1	2/2
㉒	754x346x16	1	2/2
㉓	405x826x3	2	1/2
㉔	347x826x3	2	1/2

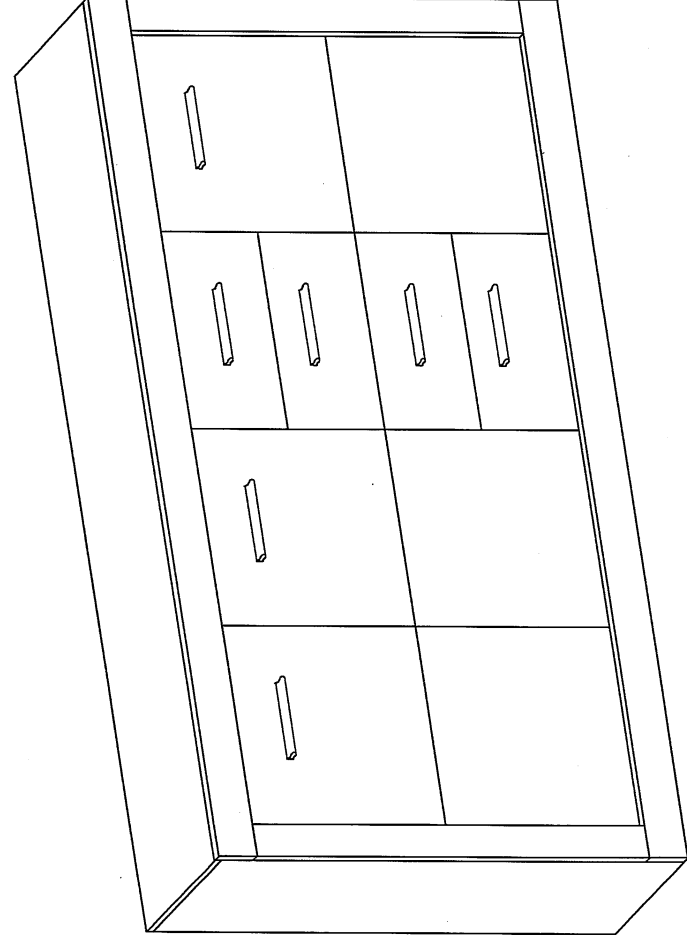

D		H1		J		S1		S		B		W		W1		M		A		A1		N	
D1		H		O		C		E		K		K1		P		G		F		G		U	

CAN CAN Kommode 3

Nr 2/8

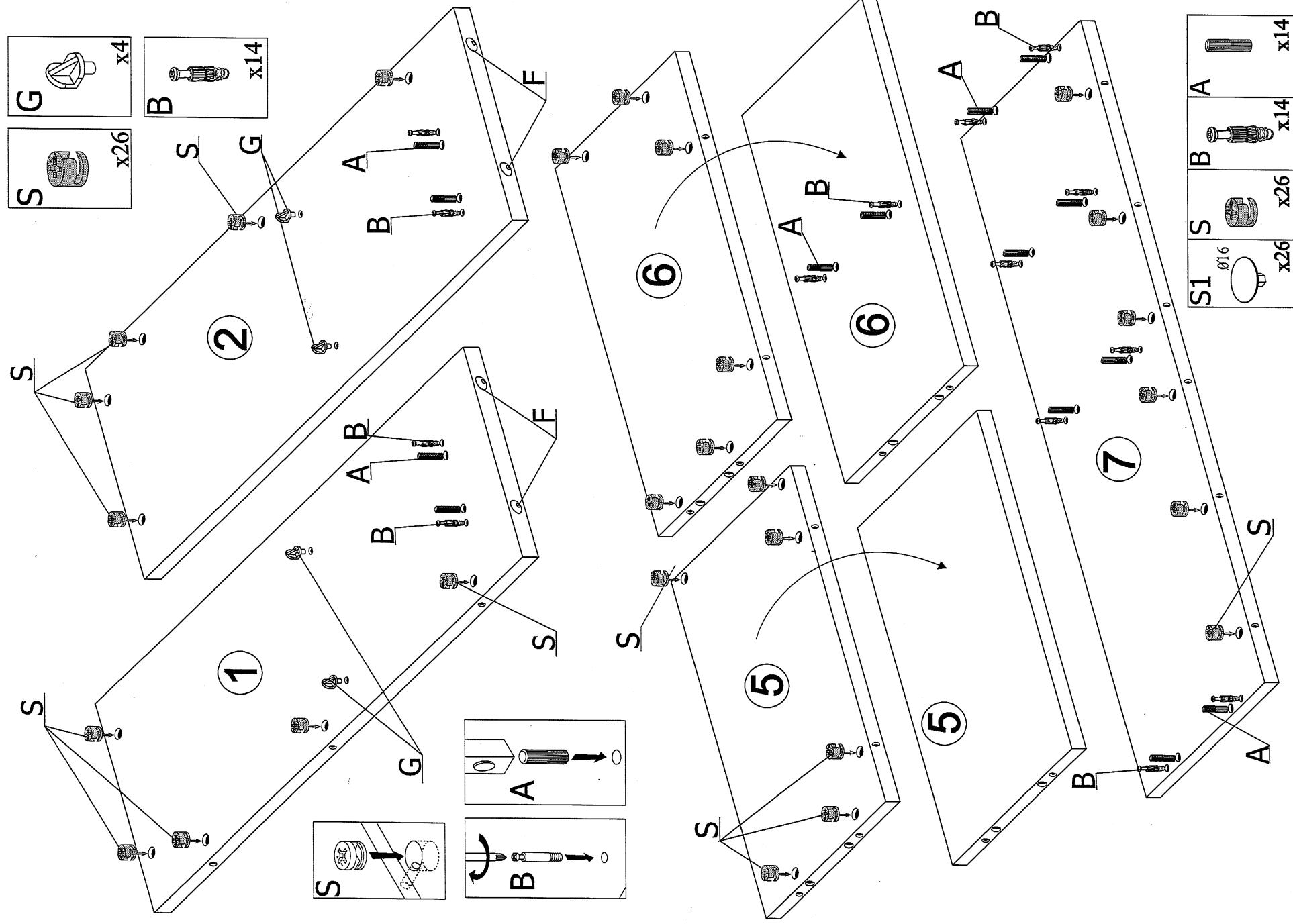

CAN CAN Kommode 3

Nr 3/8

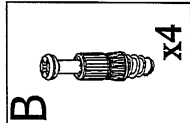
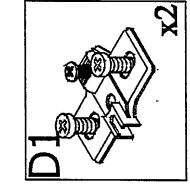
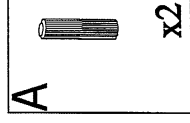
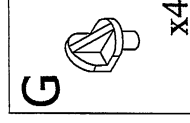
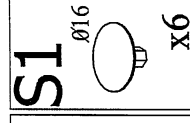
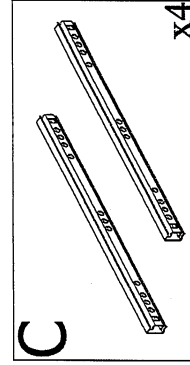
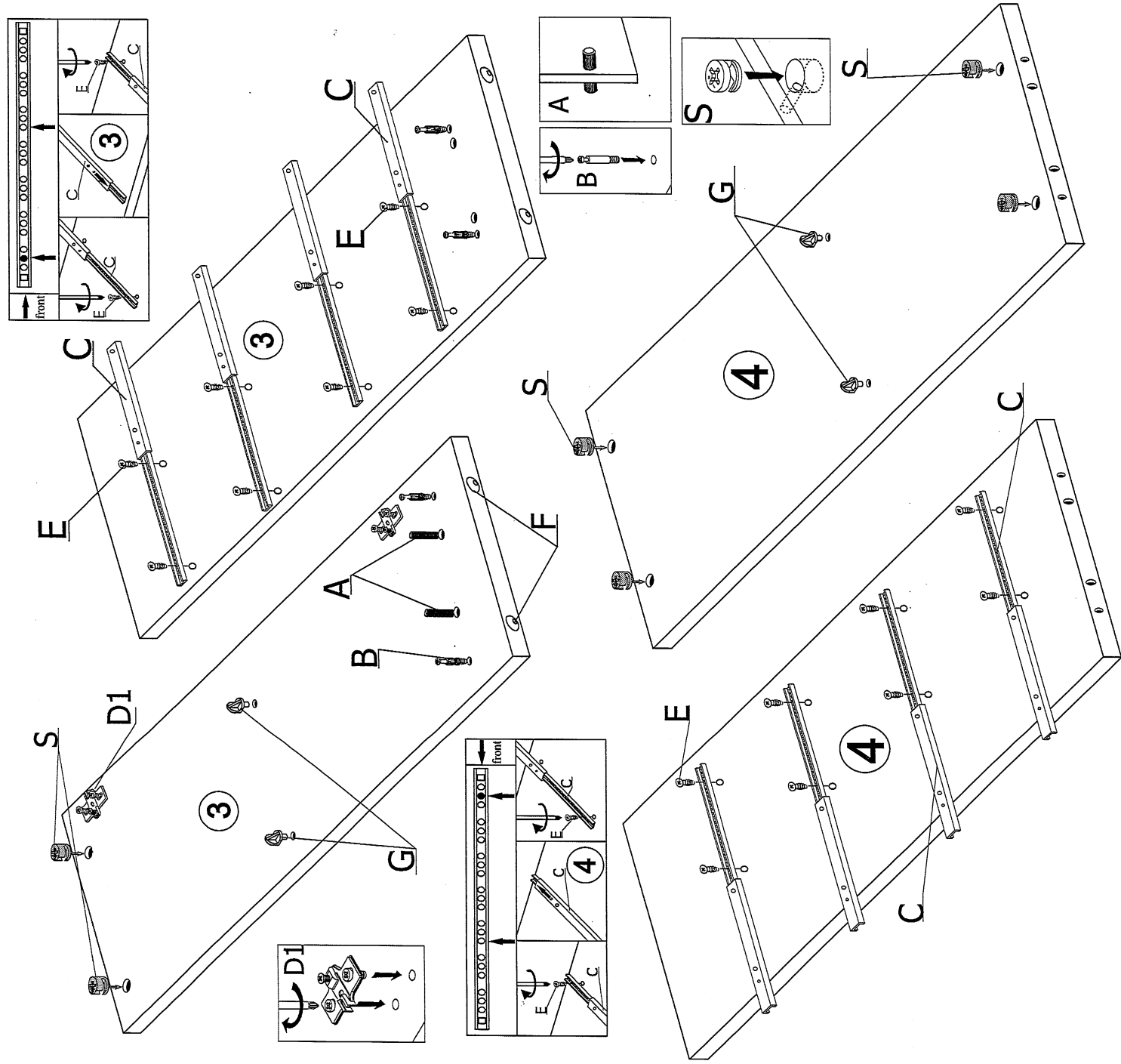

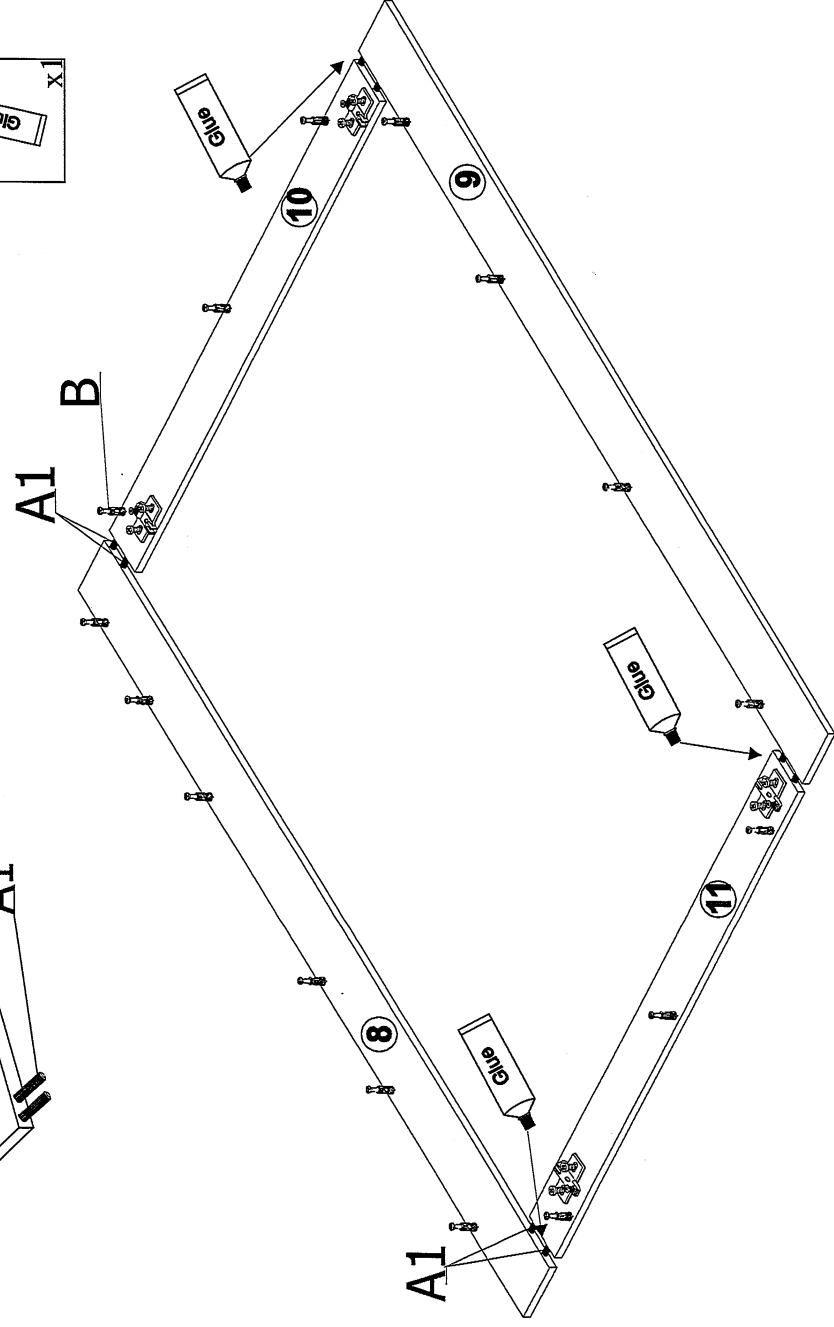
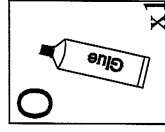
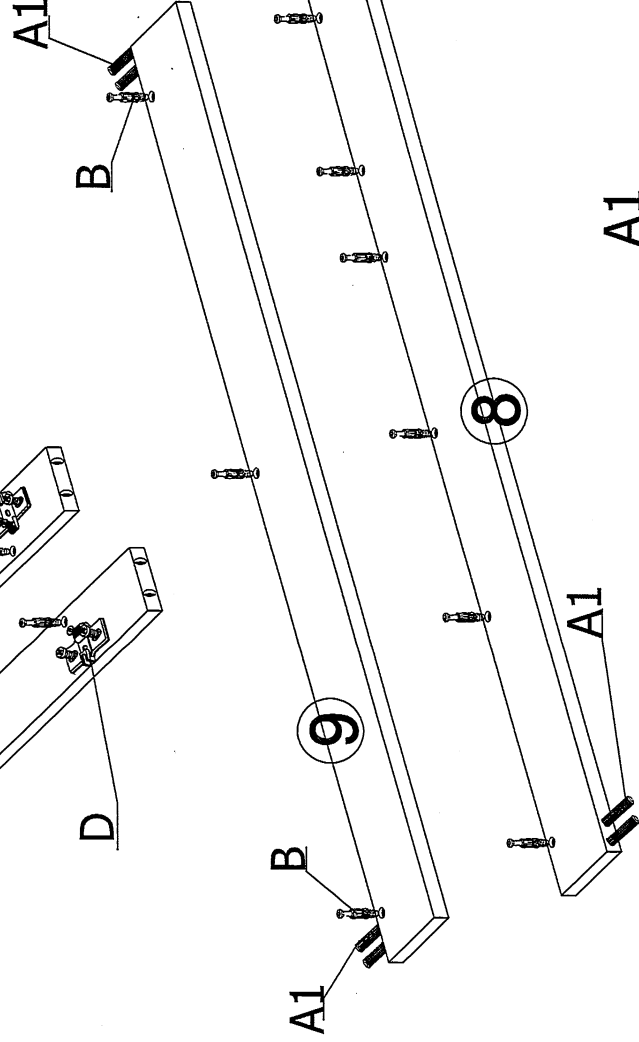
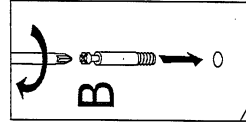
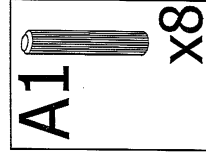
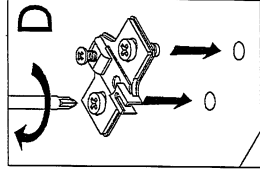
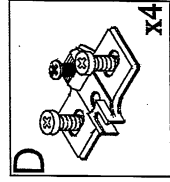
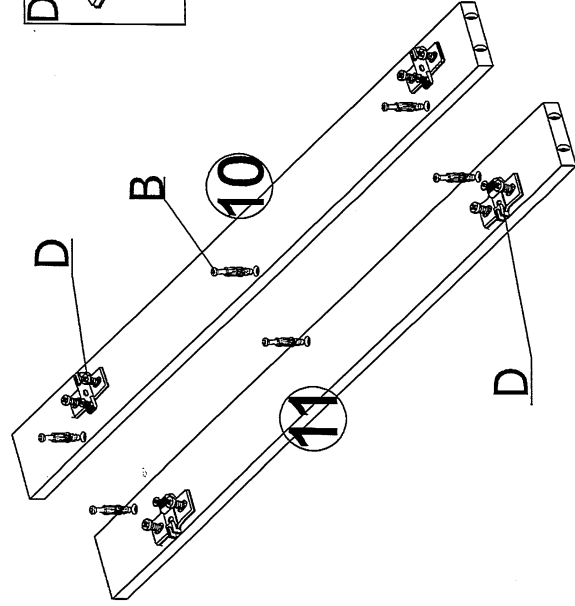

CAN CAN Kommode 3

Nr 5/8

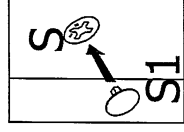
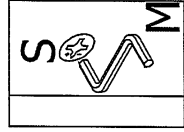
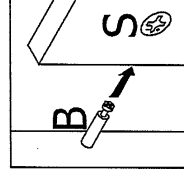
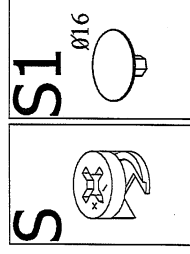
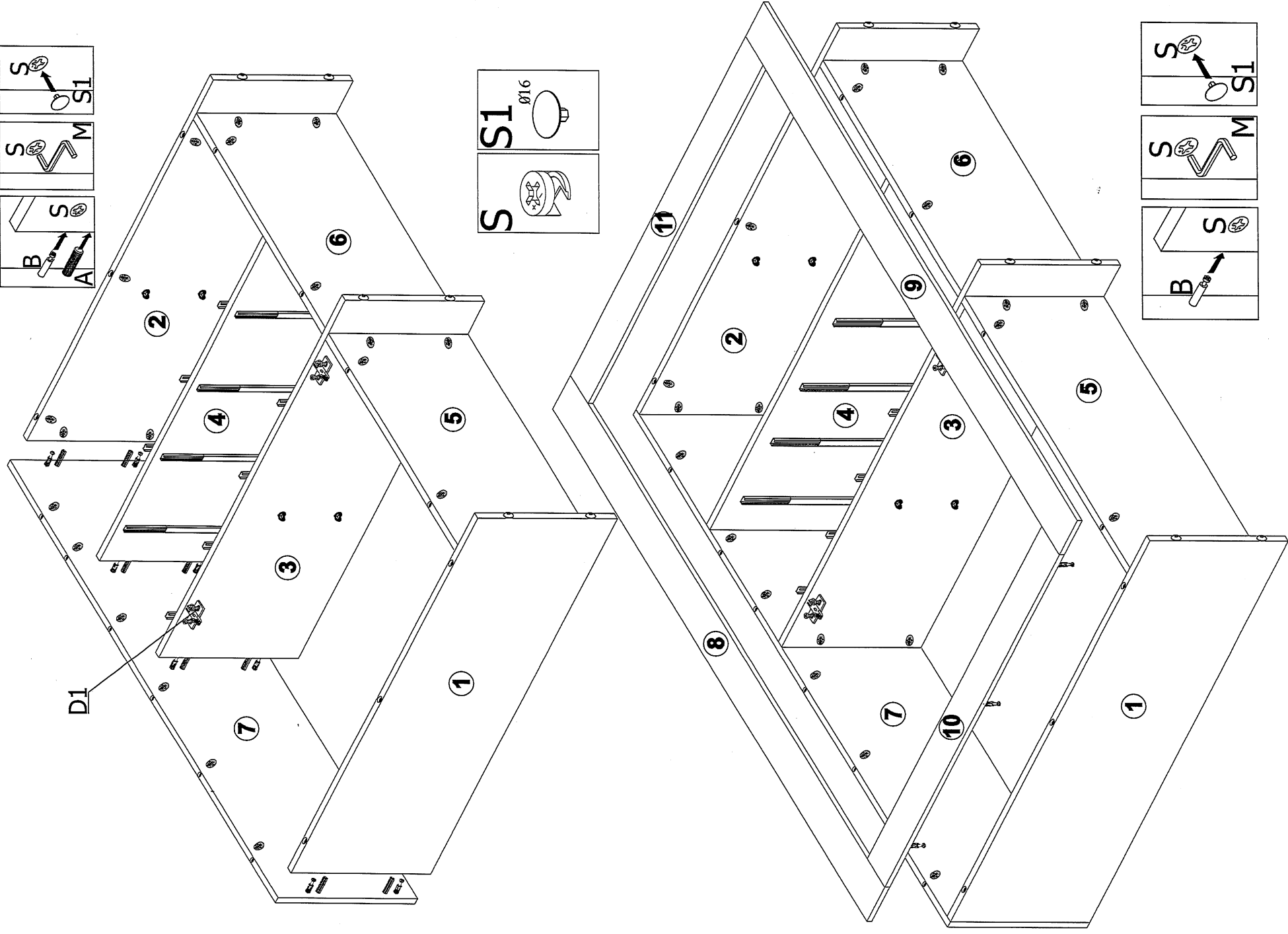
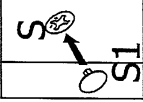
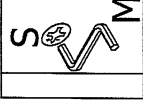
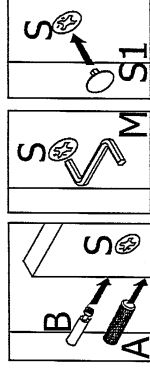

CAN CAN Kommode 3

Nr 6/8

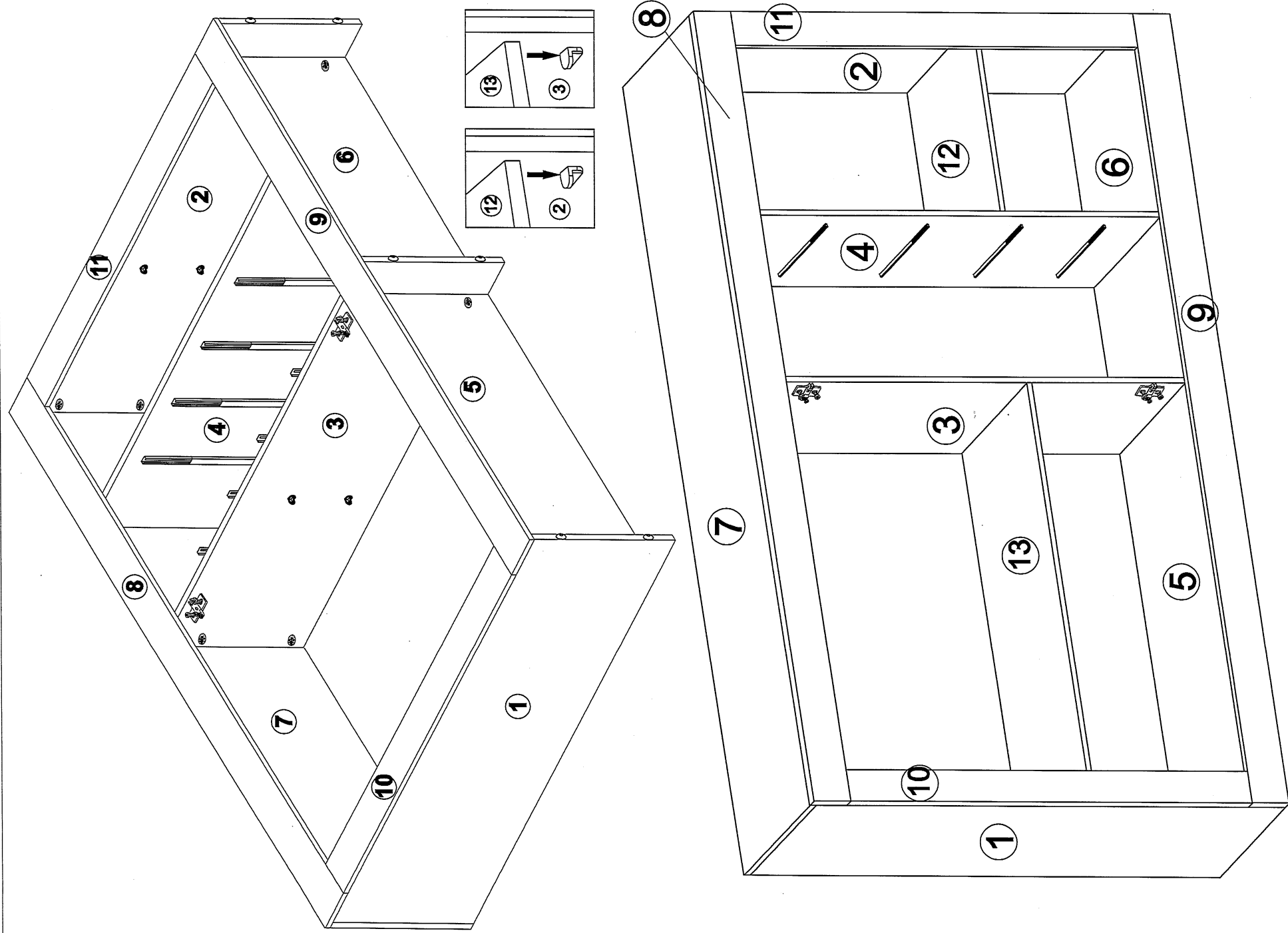

CAN CAN Kommode 3

Nr 7/8

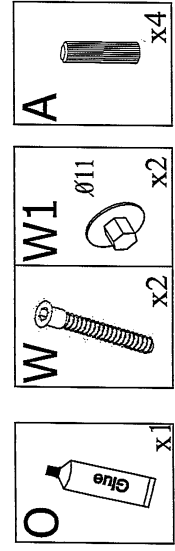

M

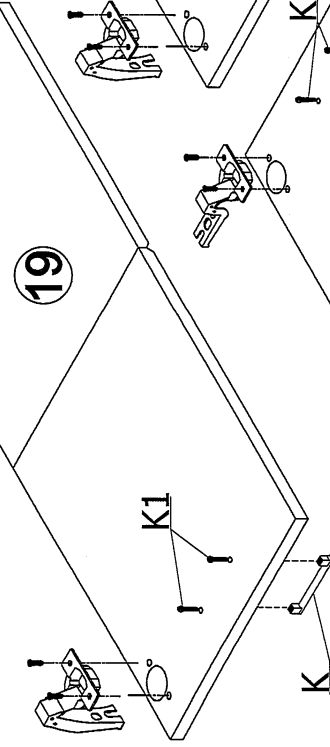
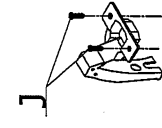
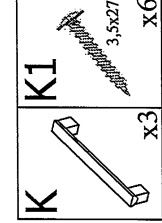
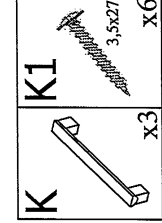
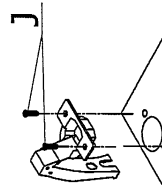
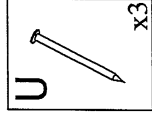
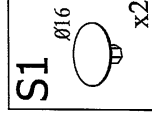
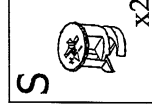
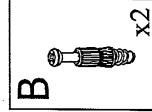
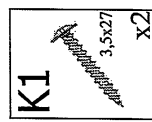
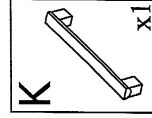
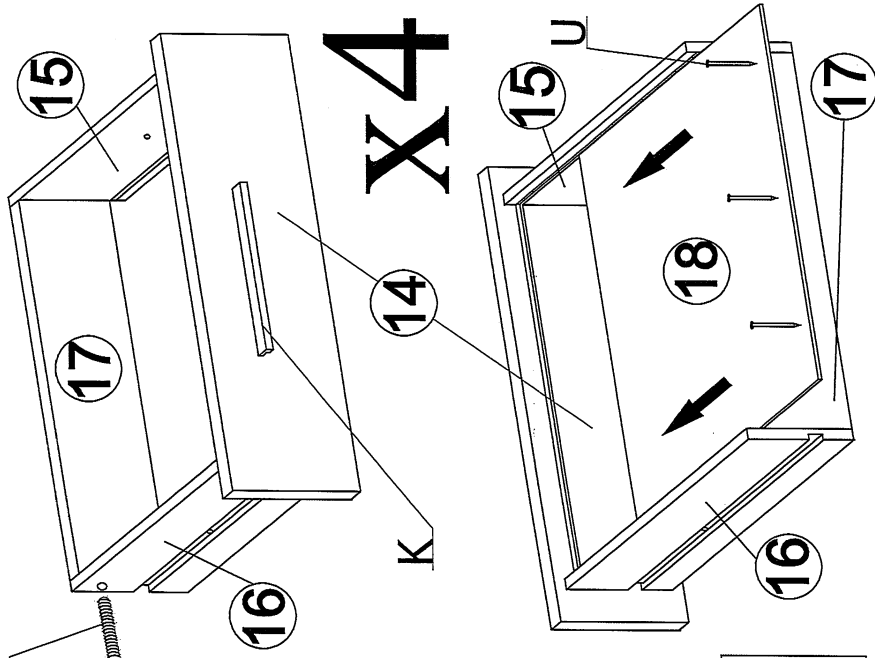
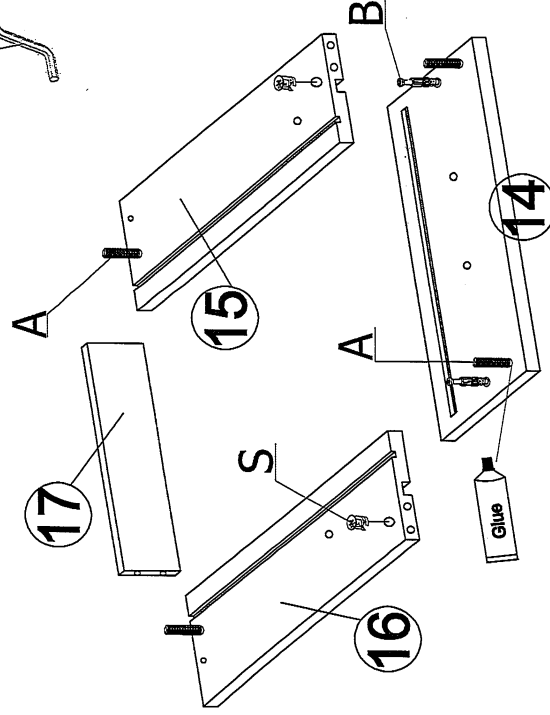
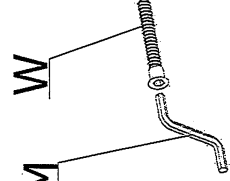

19

20

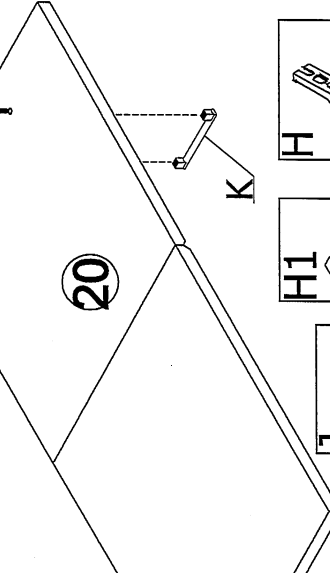

21

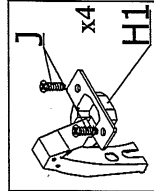
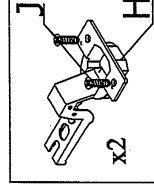
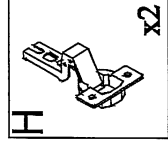
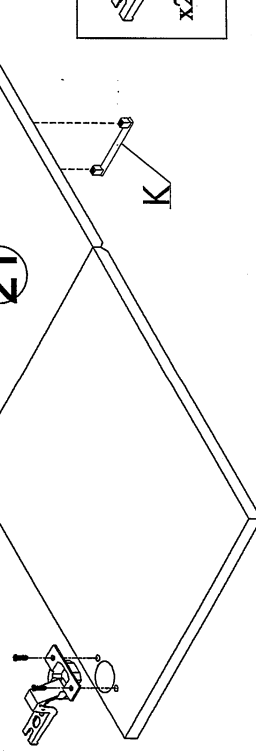

CAN CAN Kommode 3

Nr 8/8

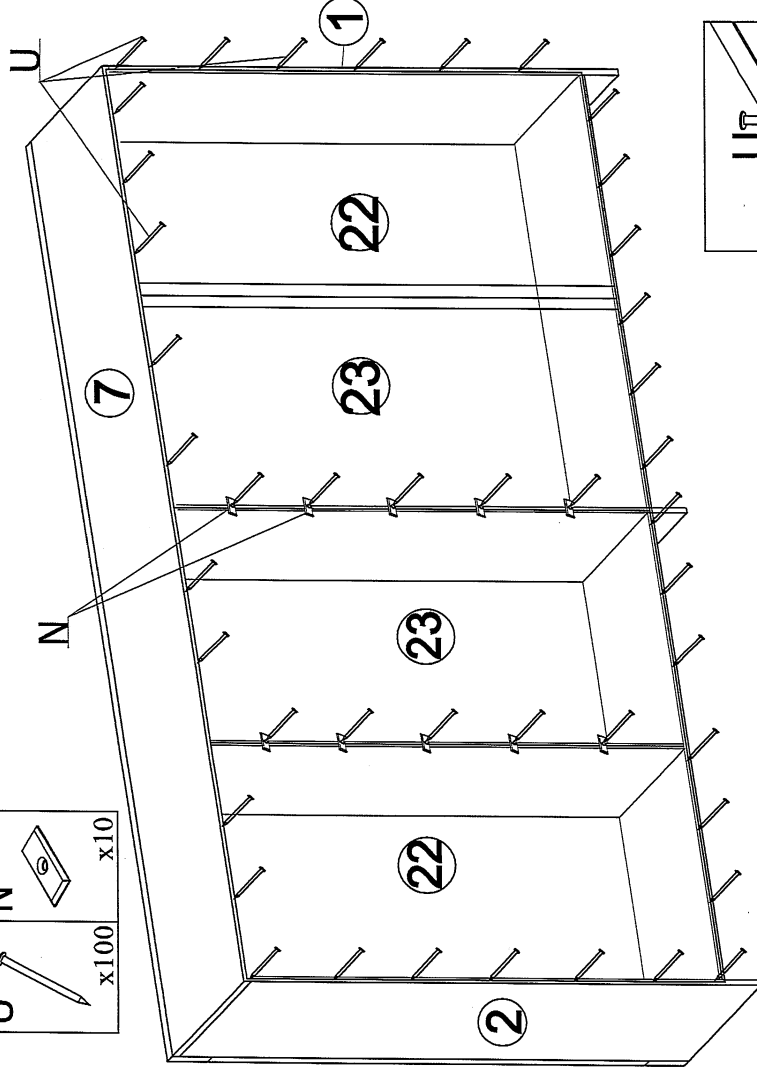
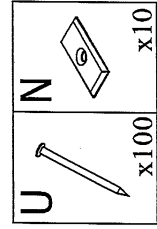

TEILENUMMER	BEZEICHNUNG	MENGE	GRÖÖE
①	864x350x16	1	2/2
②	864x350x16	1	2/2
③	864x350x16	1	2/2
④	804x350x16	1	2/2
⑤	736x350x16	1	1/2
⑥	736x350x16	1	1/2
⑦	1520x353x16	1	1/2
⑧	1521x60x16	1	1/2
⑨	1521x60x16	1	1/2
⑩	759x60x16	1	1/2
⑪	759x60x16	1	1/2
⑫	385x350x16	1	1/2
⑬	736x350x16	1	1/2
⑭	186x346x16	4	2/2
⑮	310x110x16	4	1/2
⑯	310x110x16	4	1/2
⑰	293x84x16	4	1/2
⑱	307x317x3	4	1/2
⑲	754x346x16	1	2/2
⑳	754x346x16	1	2/2
㉑	754x346x16	1	2/2
㉒	405x826x3	2	1/2
㉓	347x826x3	2	1/2

