

# B

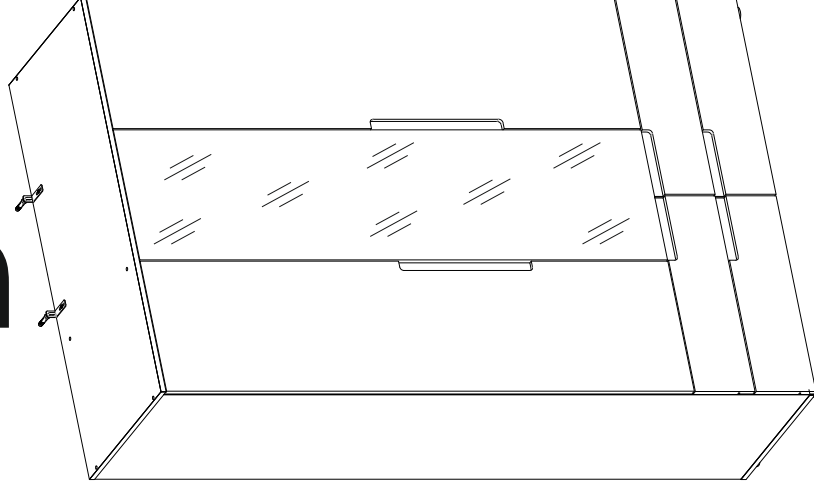

180 min



<http://www.bega-gruppe.de>



BG	Bulgarisch
CS	Tschechisch
DA	Dänisch
DE	Deutsch
ET	Eesti
EL	Ελληνικά
EN	English
ES	Español
FR	Français
FI	Finnisch
HR	Kroatisch
HU	Ungarisch
IT	Italienisch
LV	Lettisch
LT	Litauisch
NL	Niederländisch
PL	Polnisch
PT	Portugiesisch
RO	Rumänisch
SK	Slowakisch
SL	Slowenisch
SV	Schwedisch

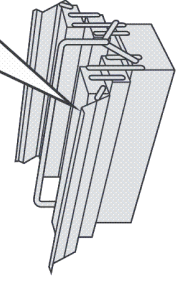
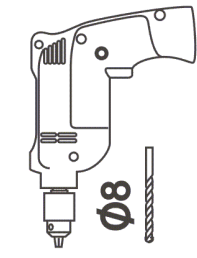
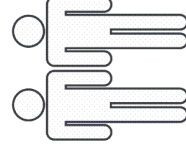
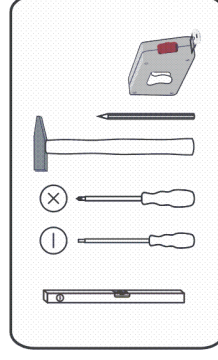
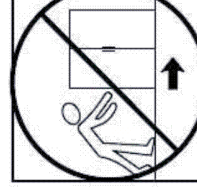
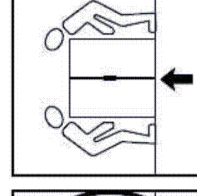
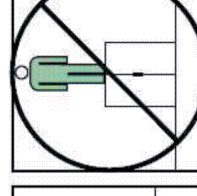
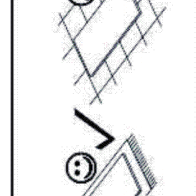
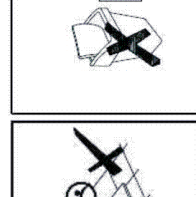
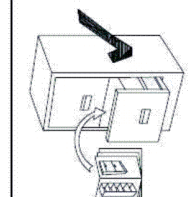
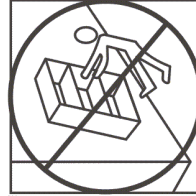
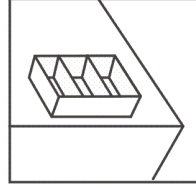
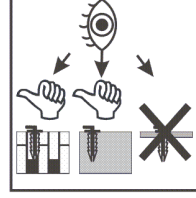

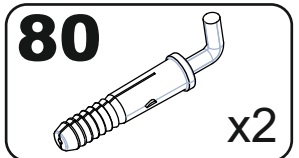
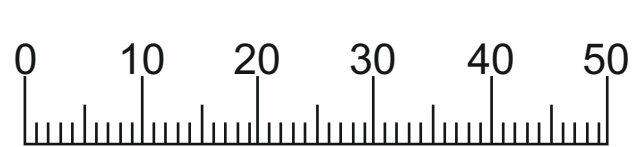
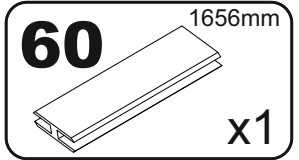
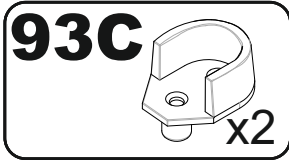
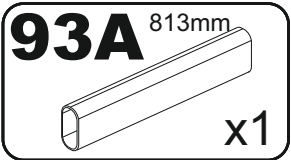
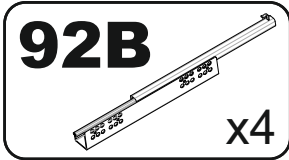
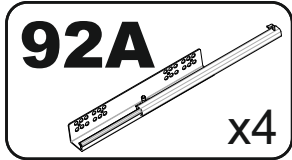
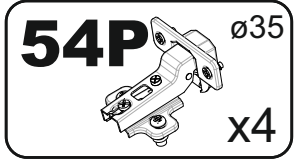
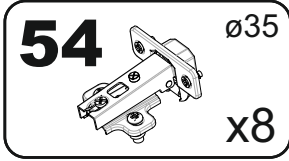
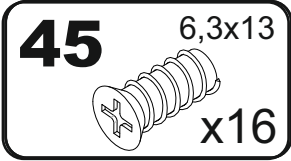
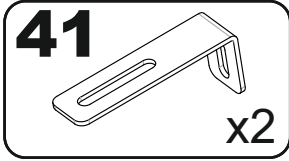
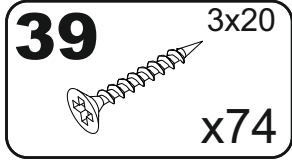
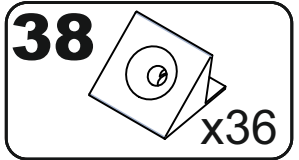
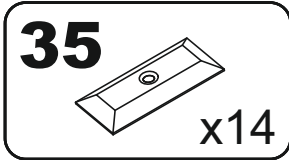
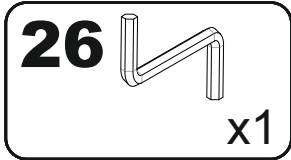
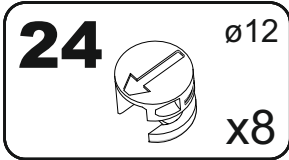
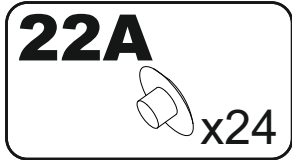
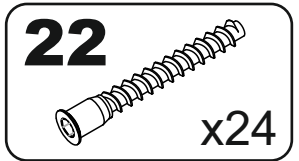
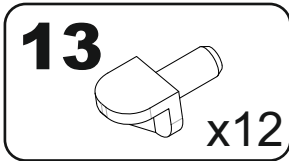
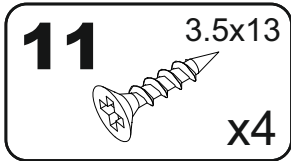
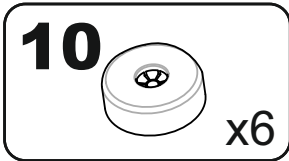
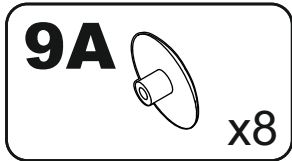
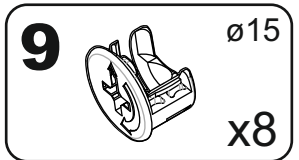
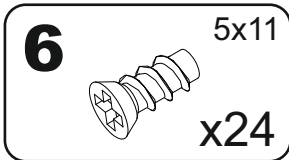
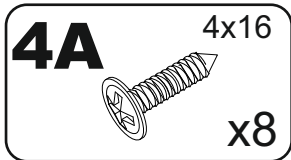
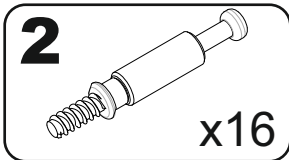
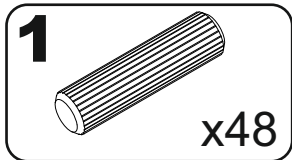
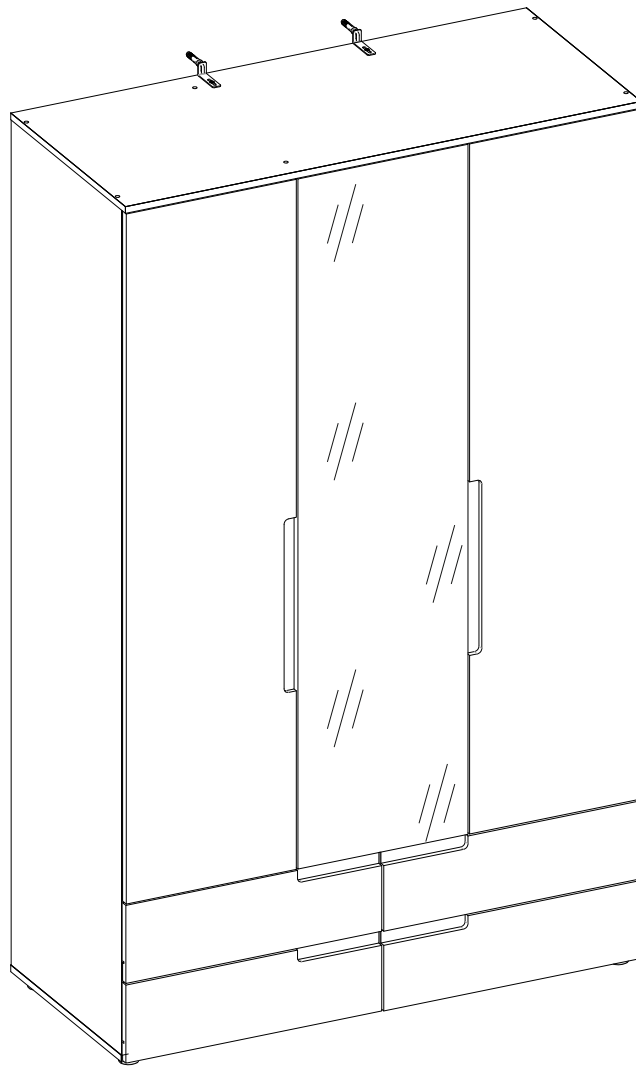
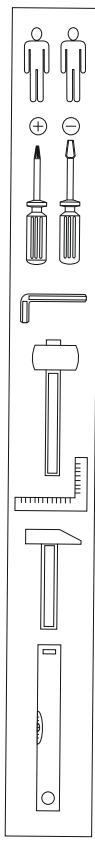

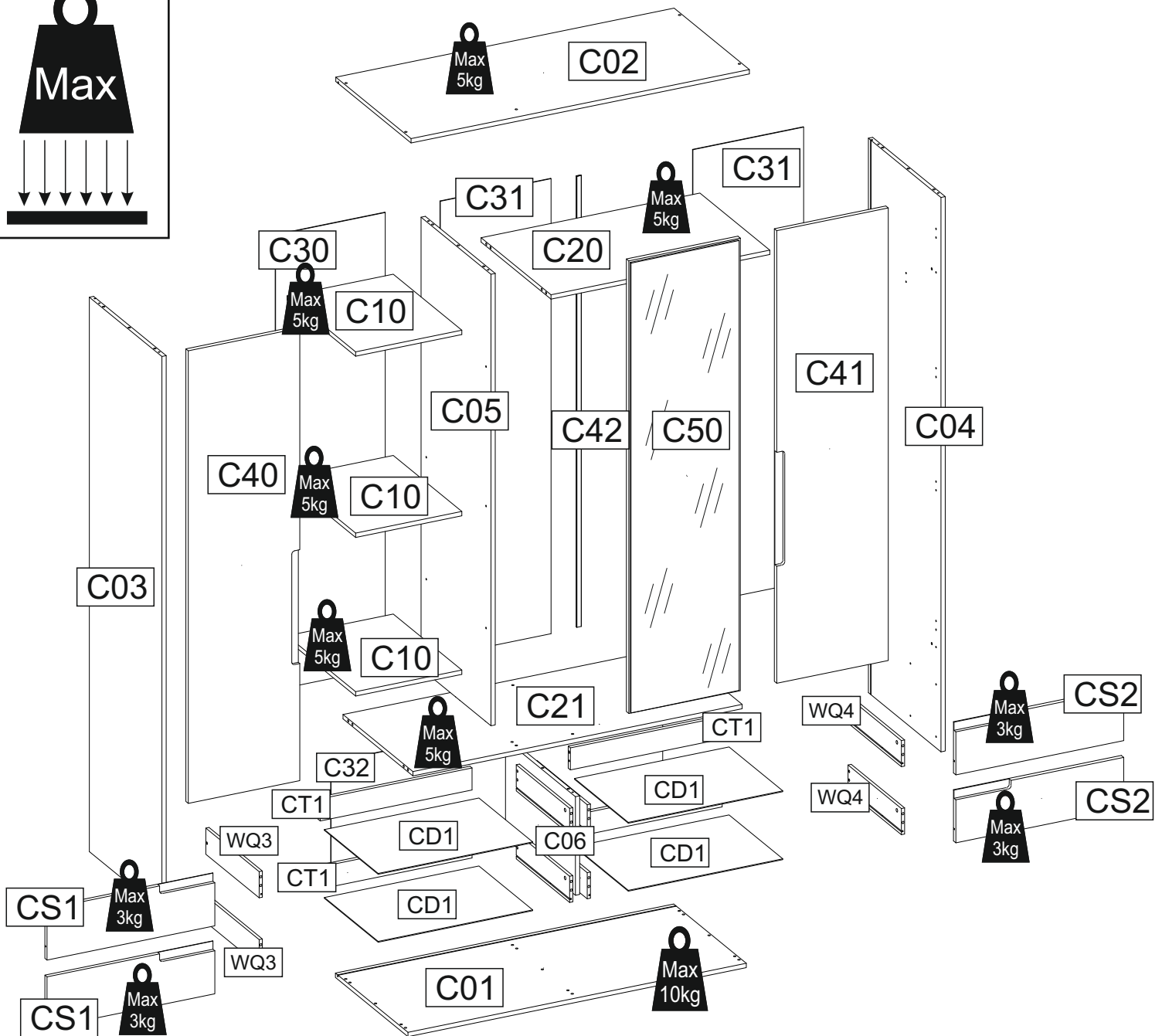
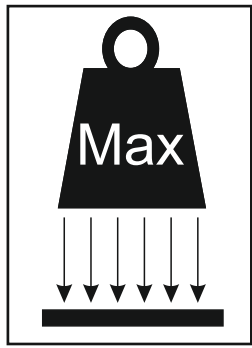

	A	B (mm)	C (mm)	D (mm)	E	F
B01		1268	544	16	1	3/4
B02		1268	564	16	1	3/4
B03		2036	544	16	1	4/4
B04		2036	544	16	1	4/4
B05		1658	524	16	1	4/4
B06		362	524	16	1	4/4
B10		398	514	16	3	1/4
B20		820	524	16	1	3/4
B21		1234	524	16	1	3/4
B30		1671	411	3	1	2/4
B31		1671	415	3	2	2/4
B32		1243	375	3	1	3/4
B40		1662	418	18	1	2/4
B41		1662	418	18	1	2/4
B42		1662	418	18	1	2/4
C50		1660	416	4	1	2/4
BD1		579	403	3	4	1/4
BS1		629	188	16	2	1/4
BS2		629	188	18	2	1/4
BT1		569	81	16	4	1/4
WQ3		400	96	12	4	1/4

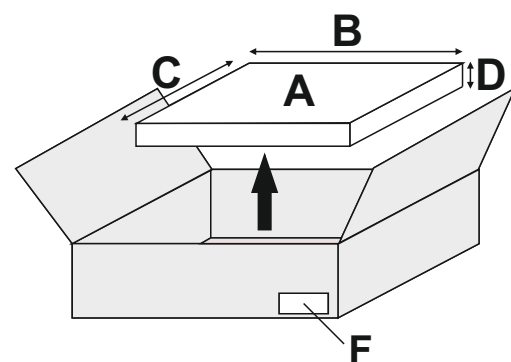

# 1

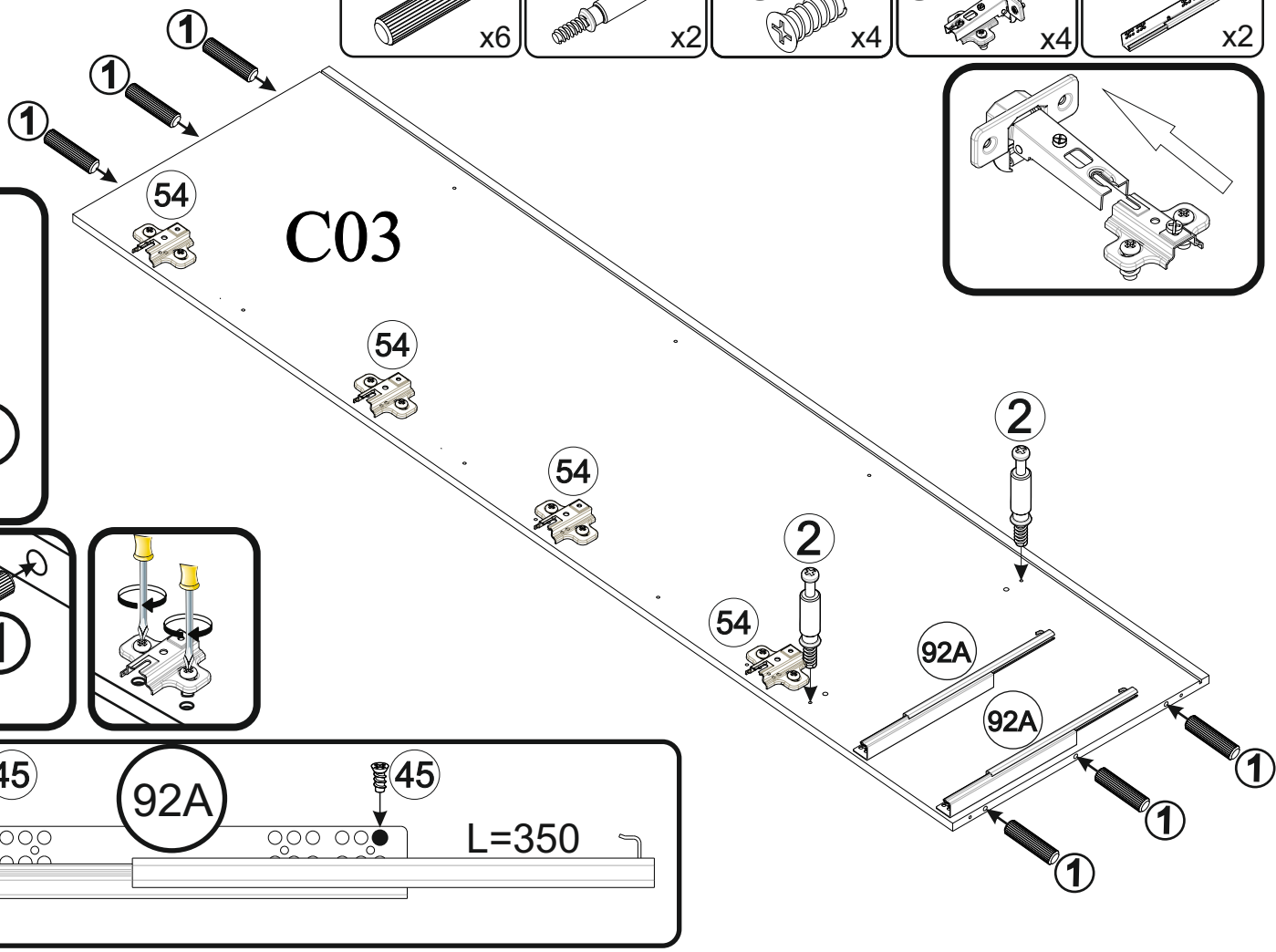
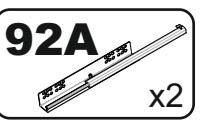
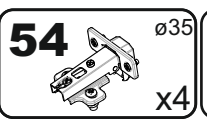
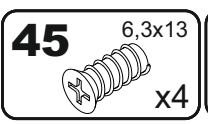
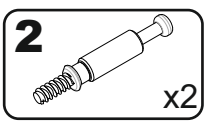
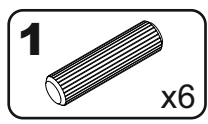

# 2

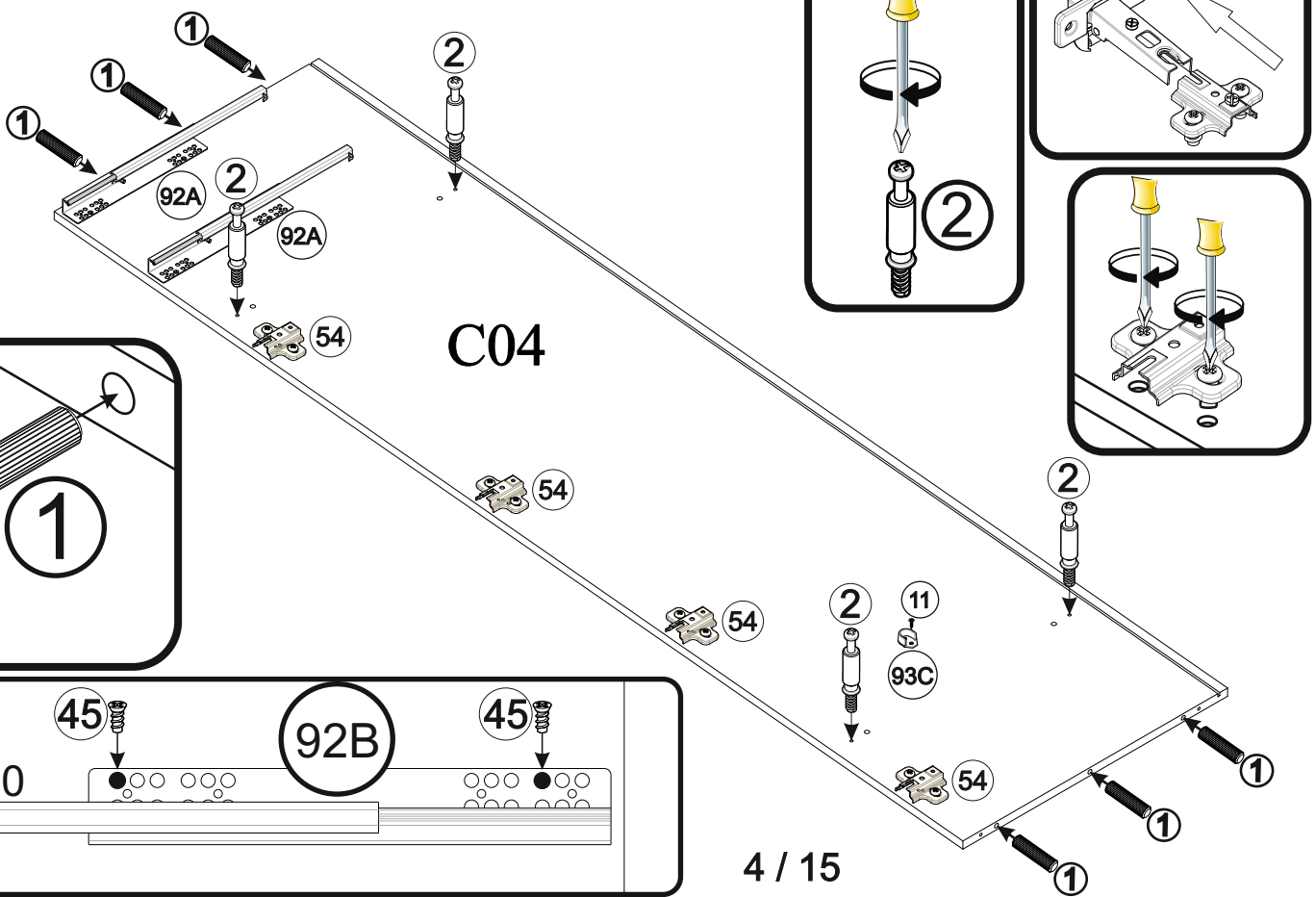
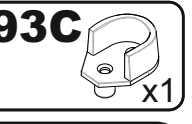
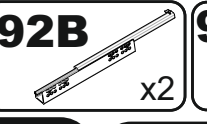
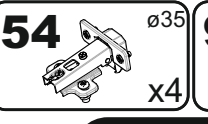
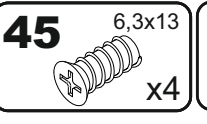
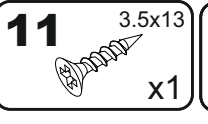
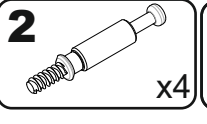
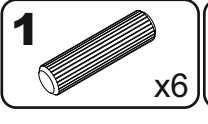

# 3

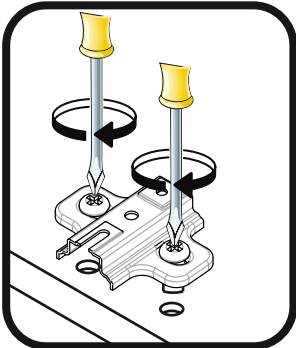
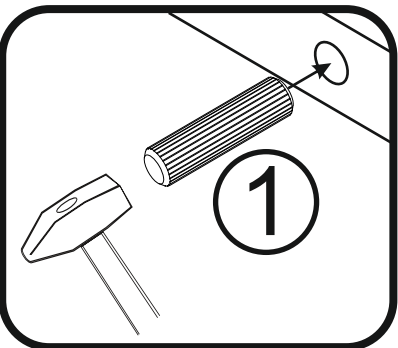
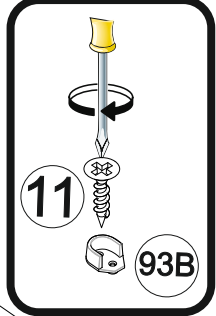
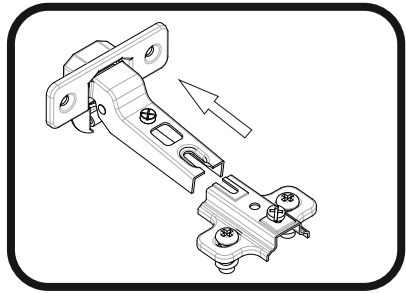
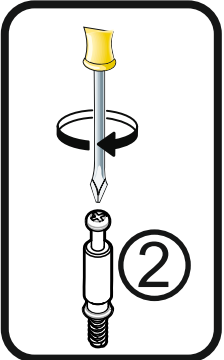
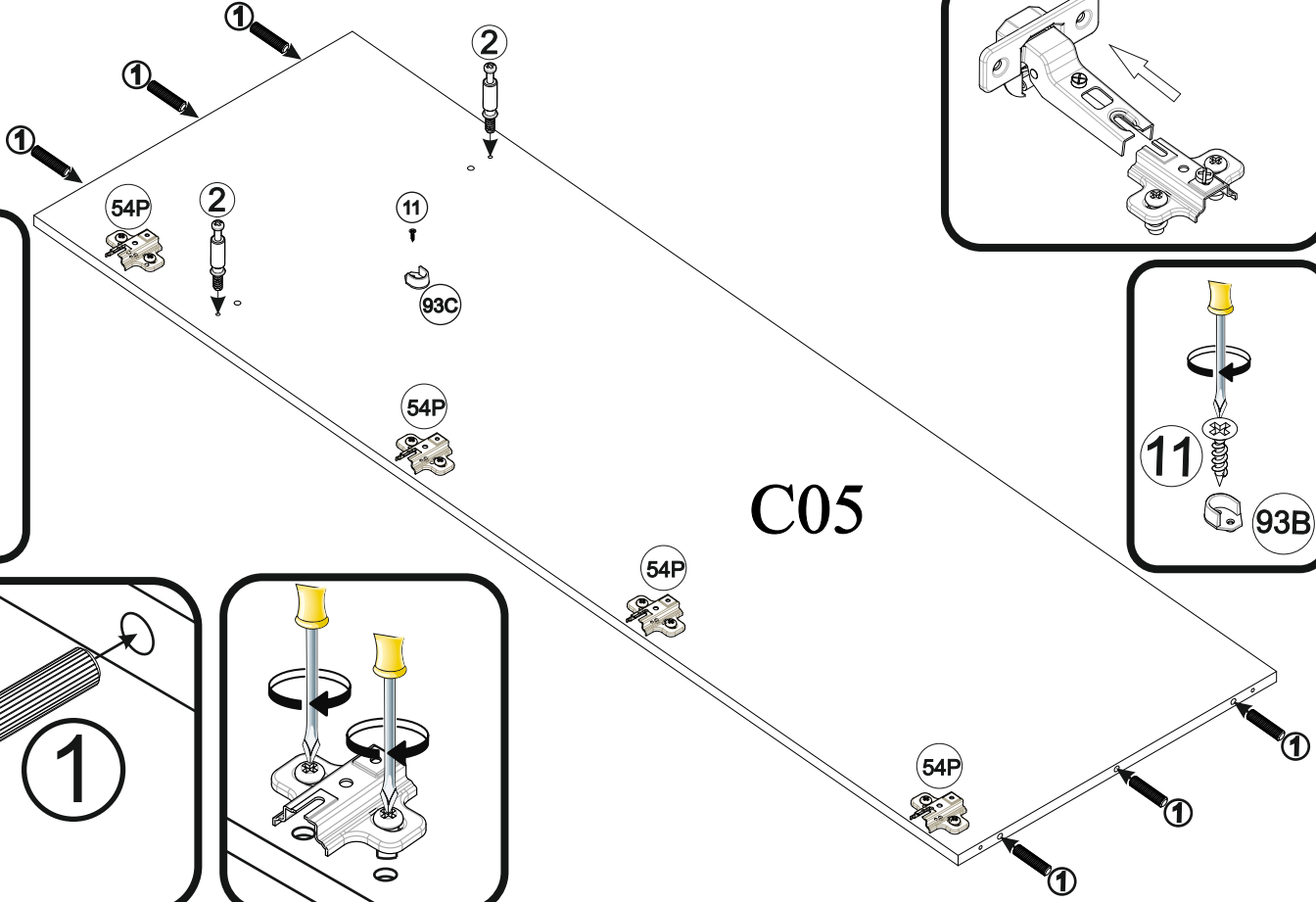
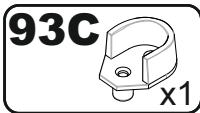
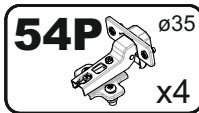
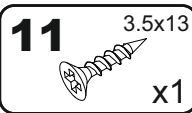
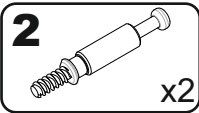
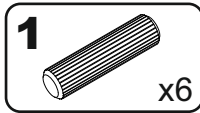

# 4

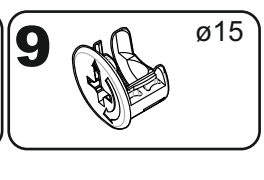
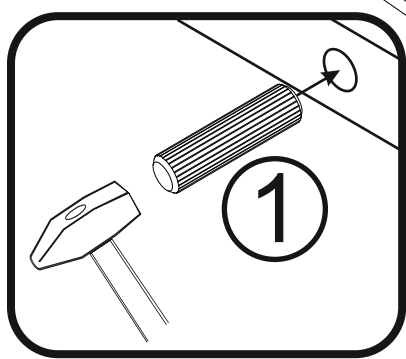
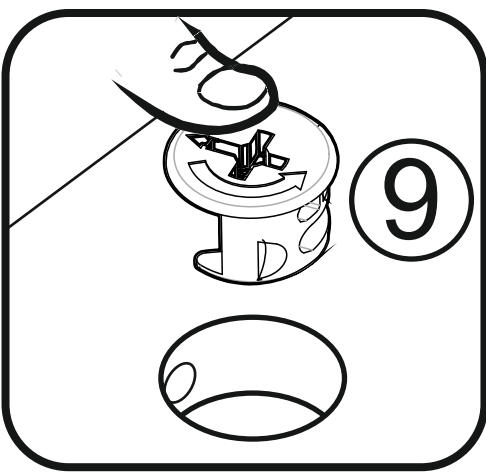
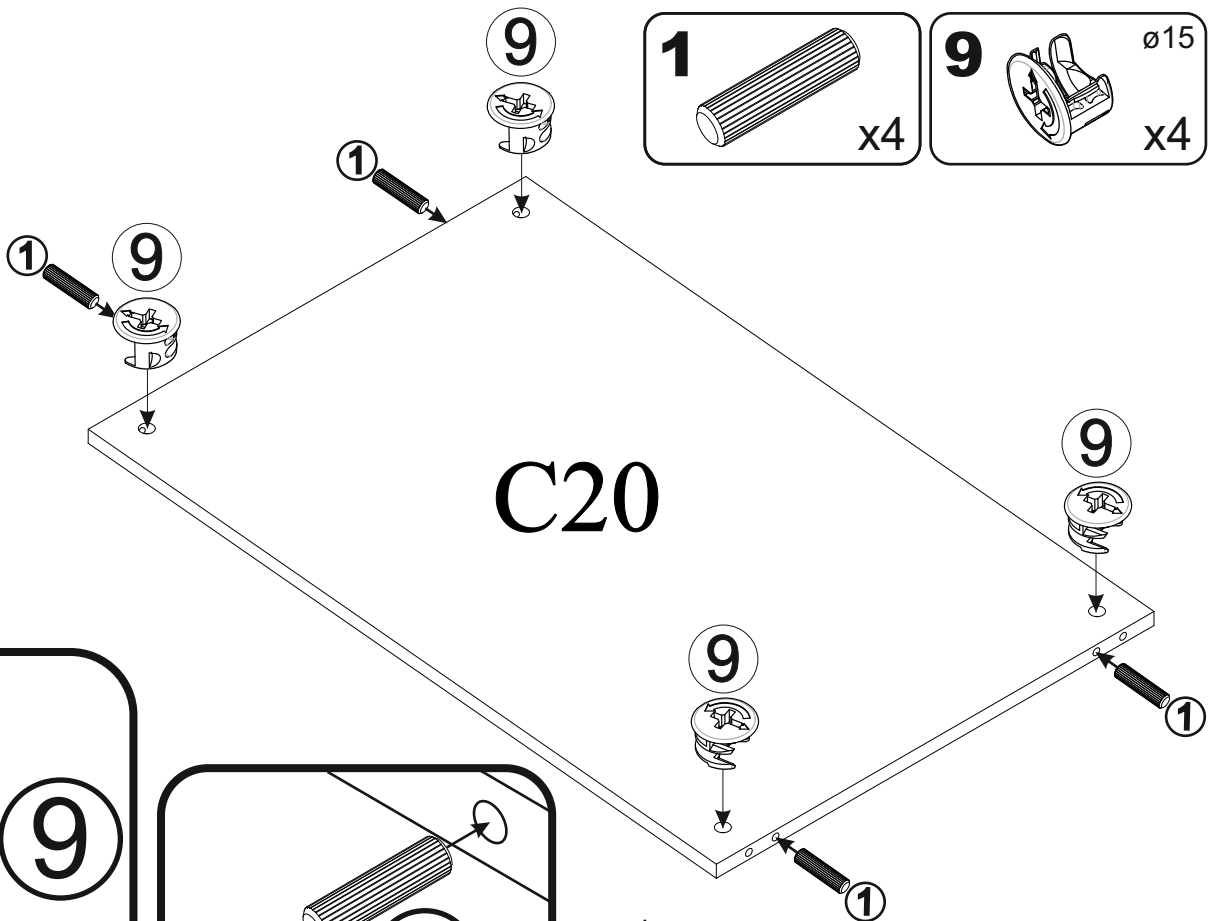
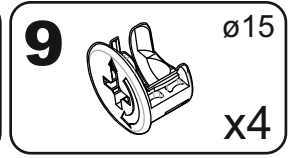
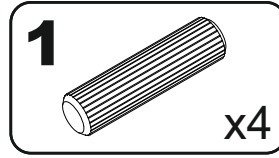



# 5

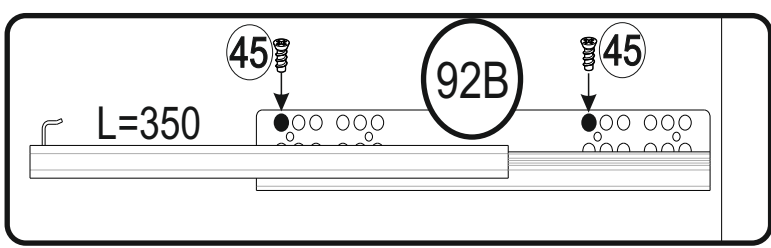
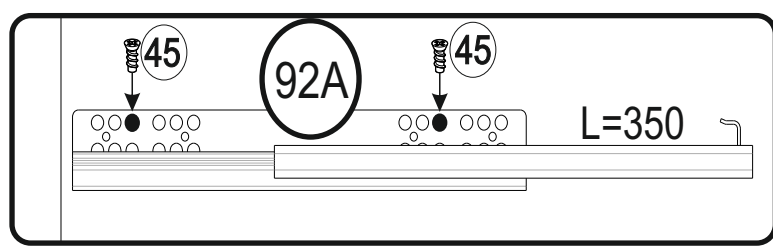
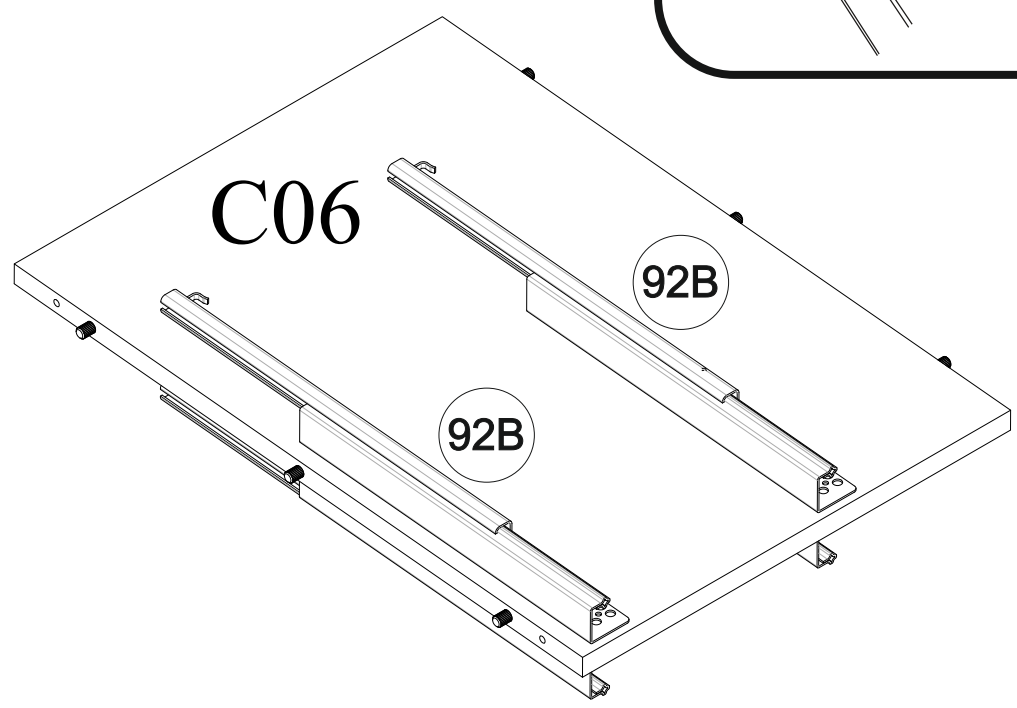
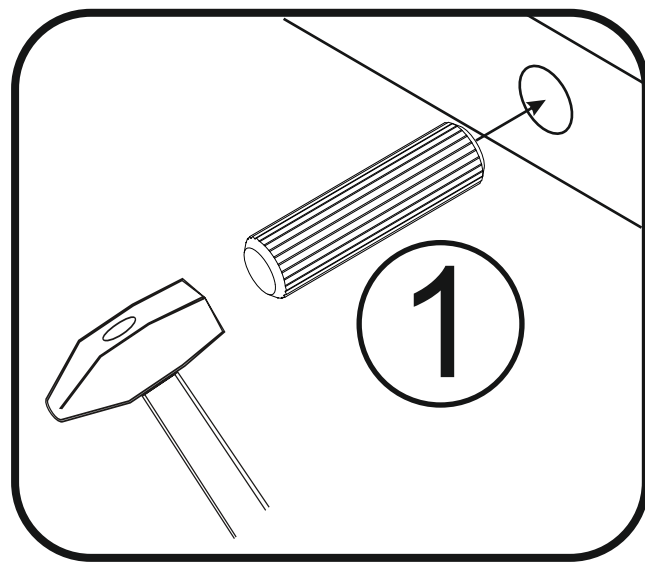
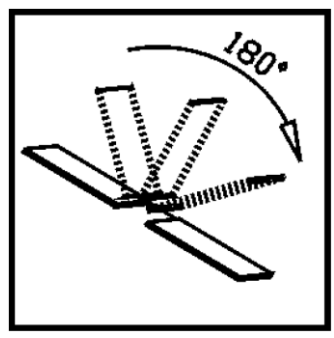
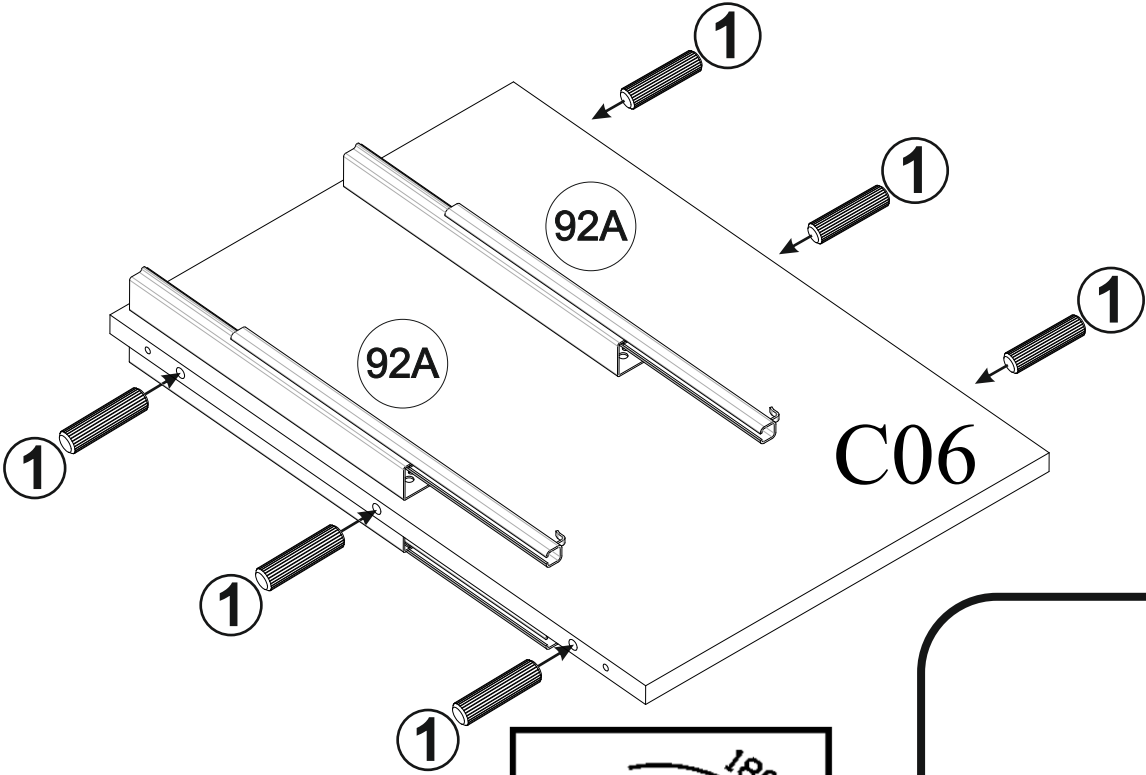
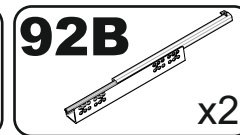
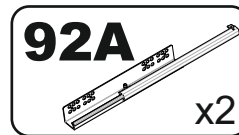
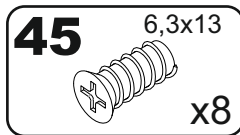
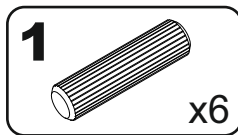



8

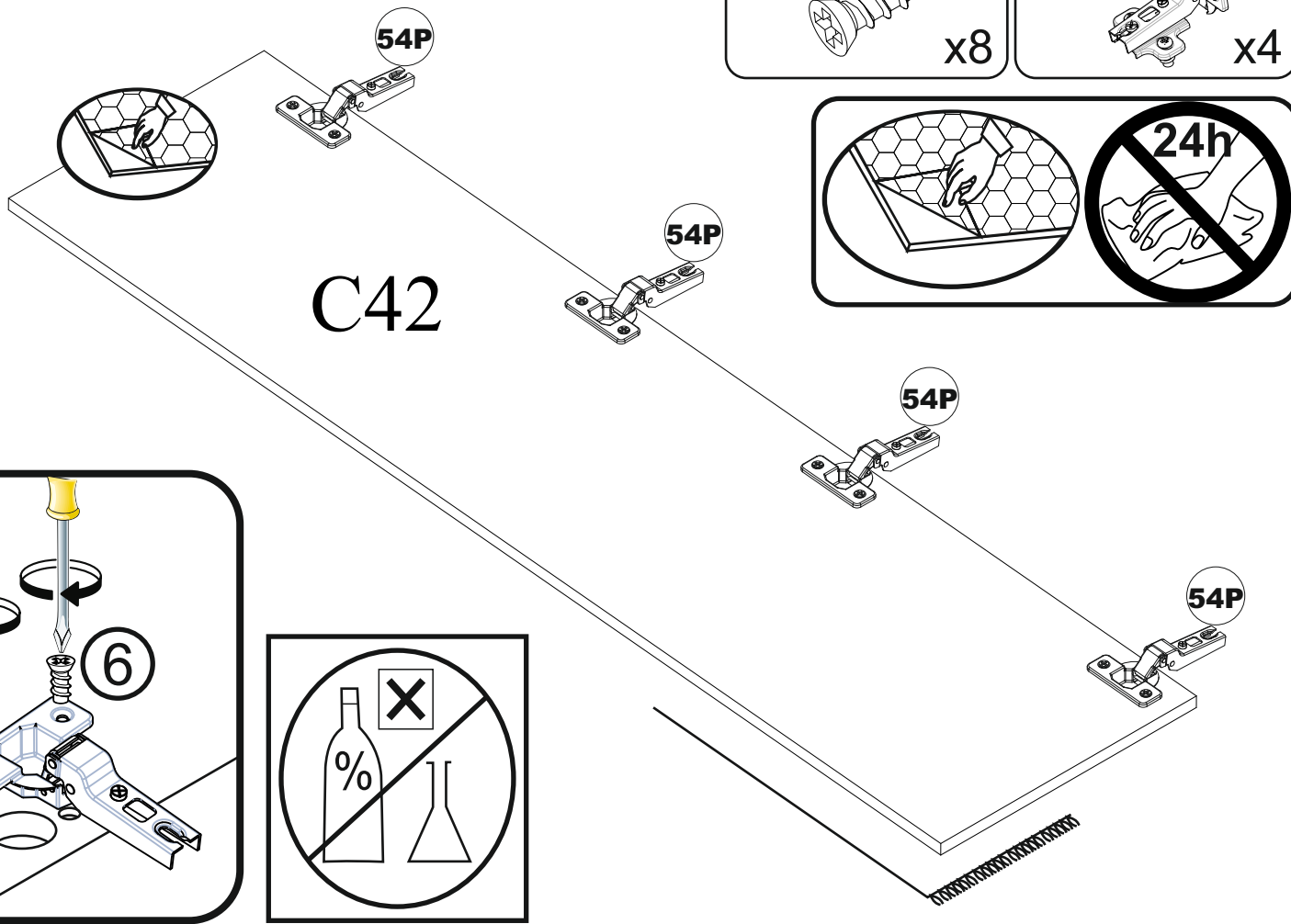

9

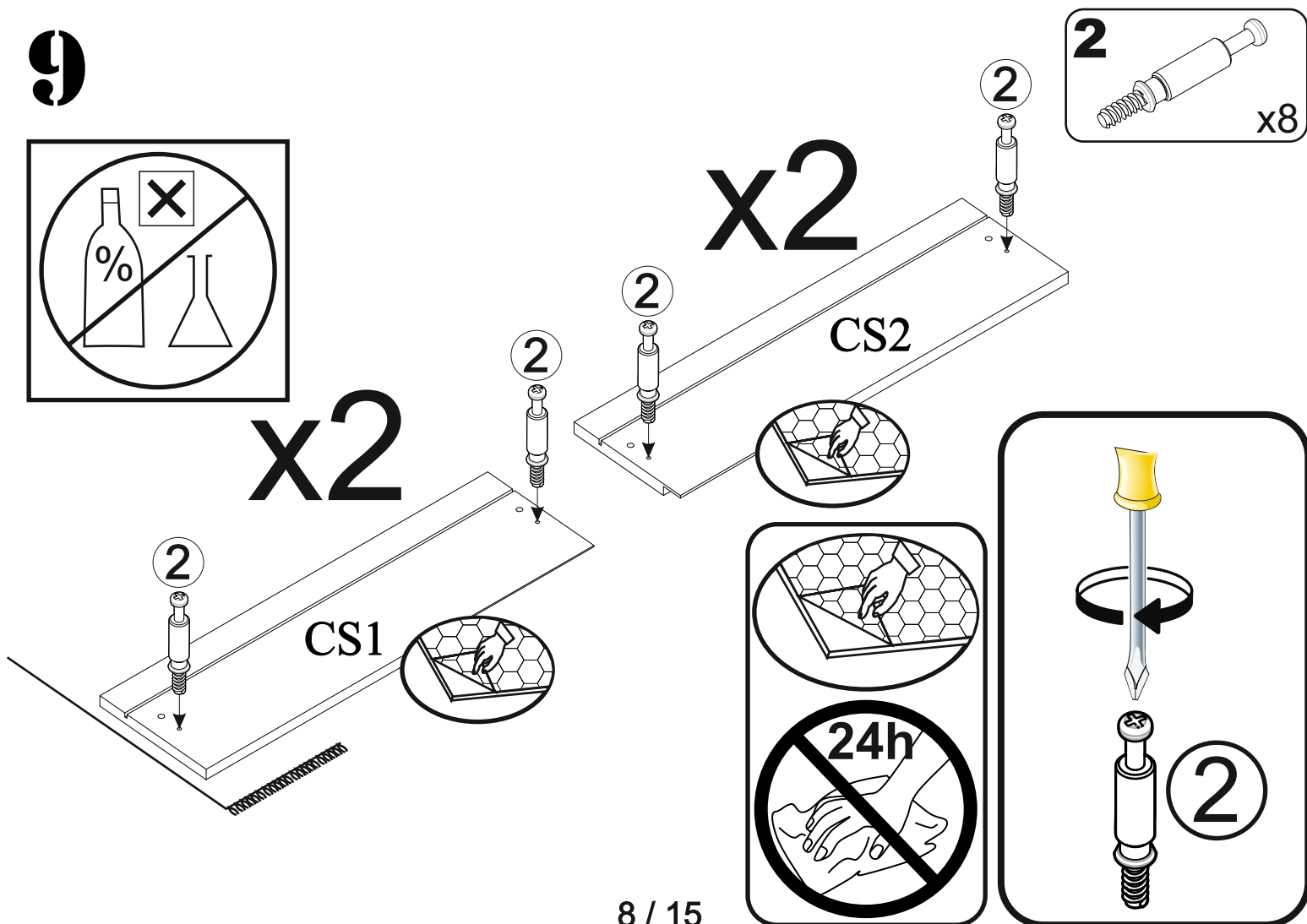



# 10

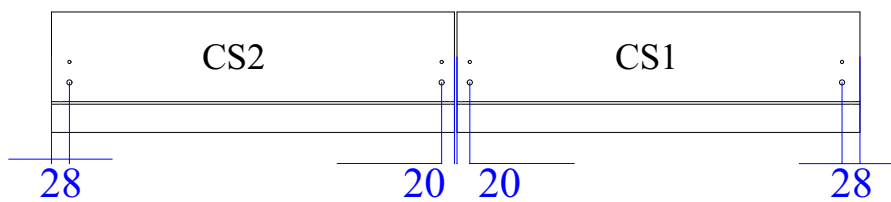
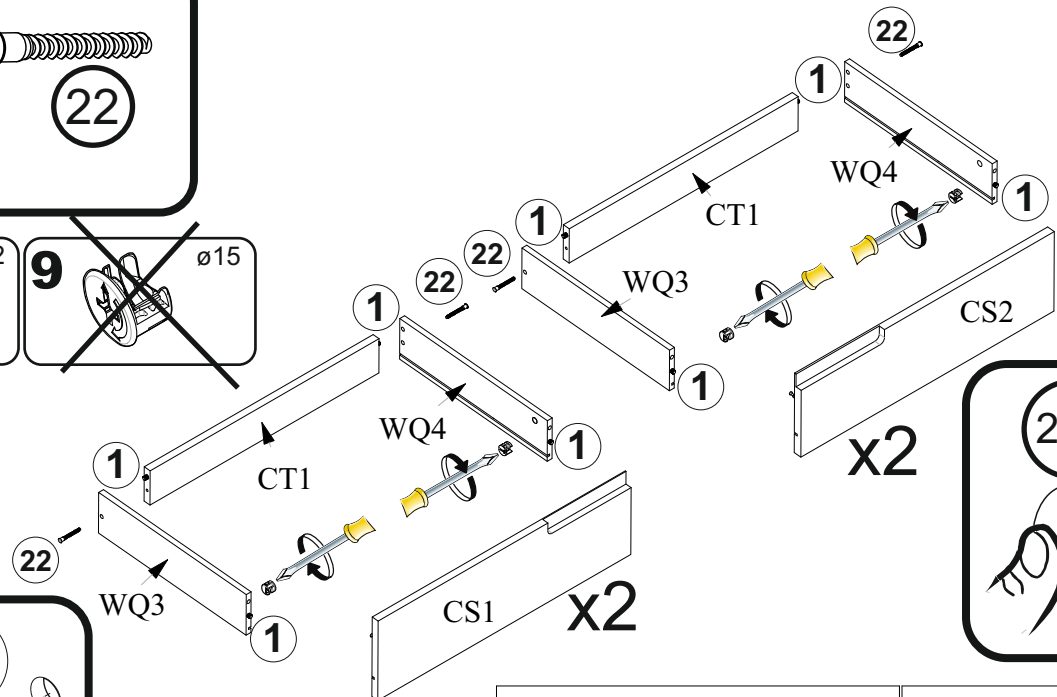
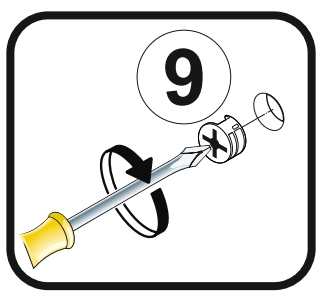
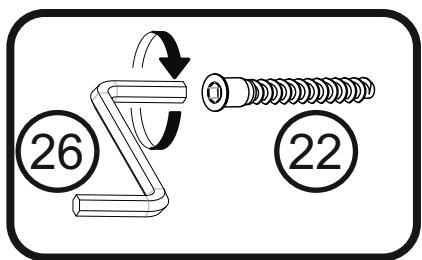
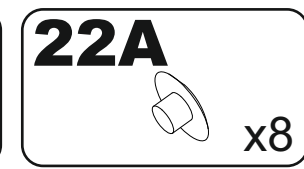
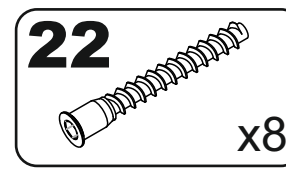
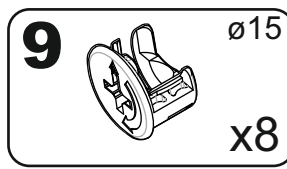
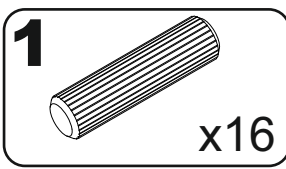

# 11

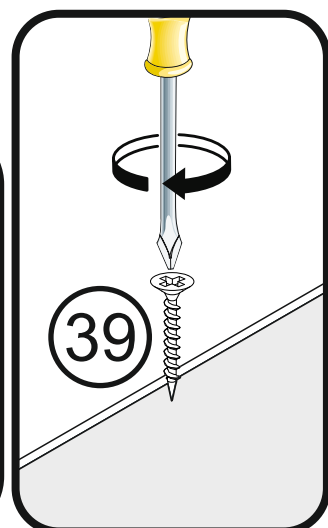
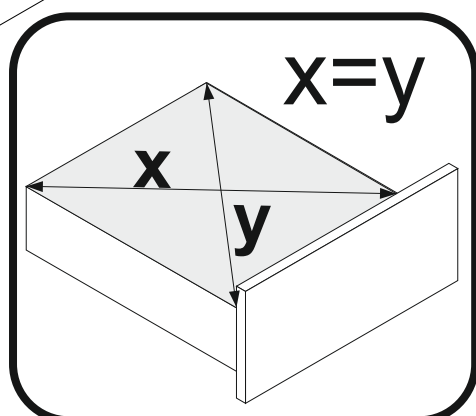
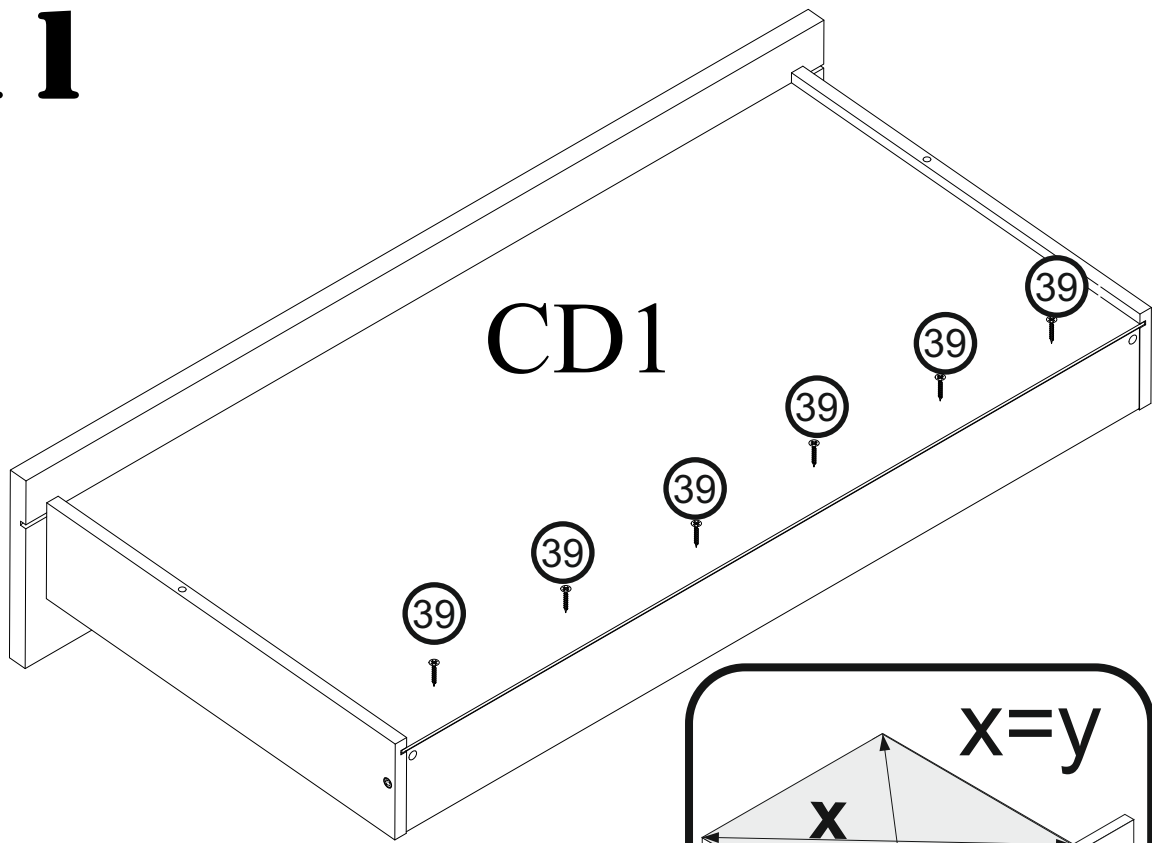
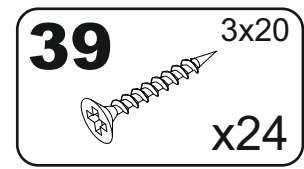

x4

# 12

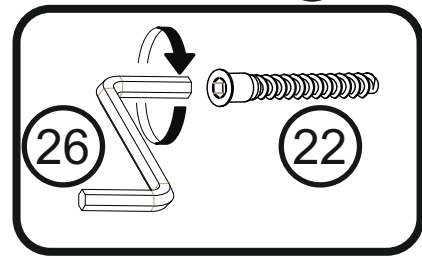
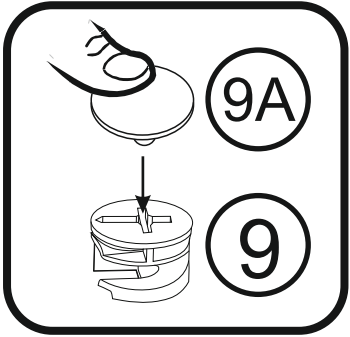
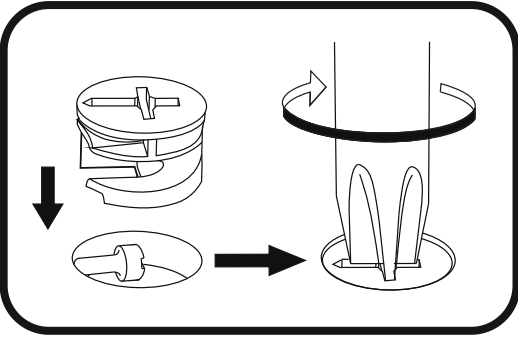
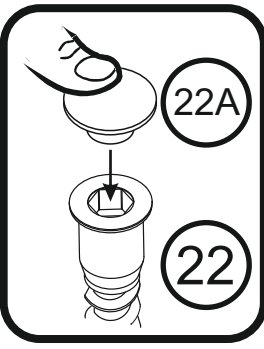
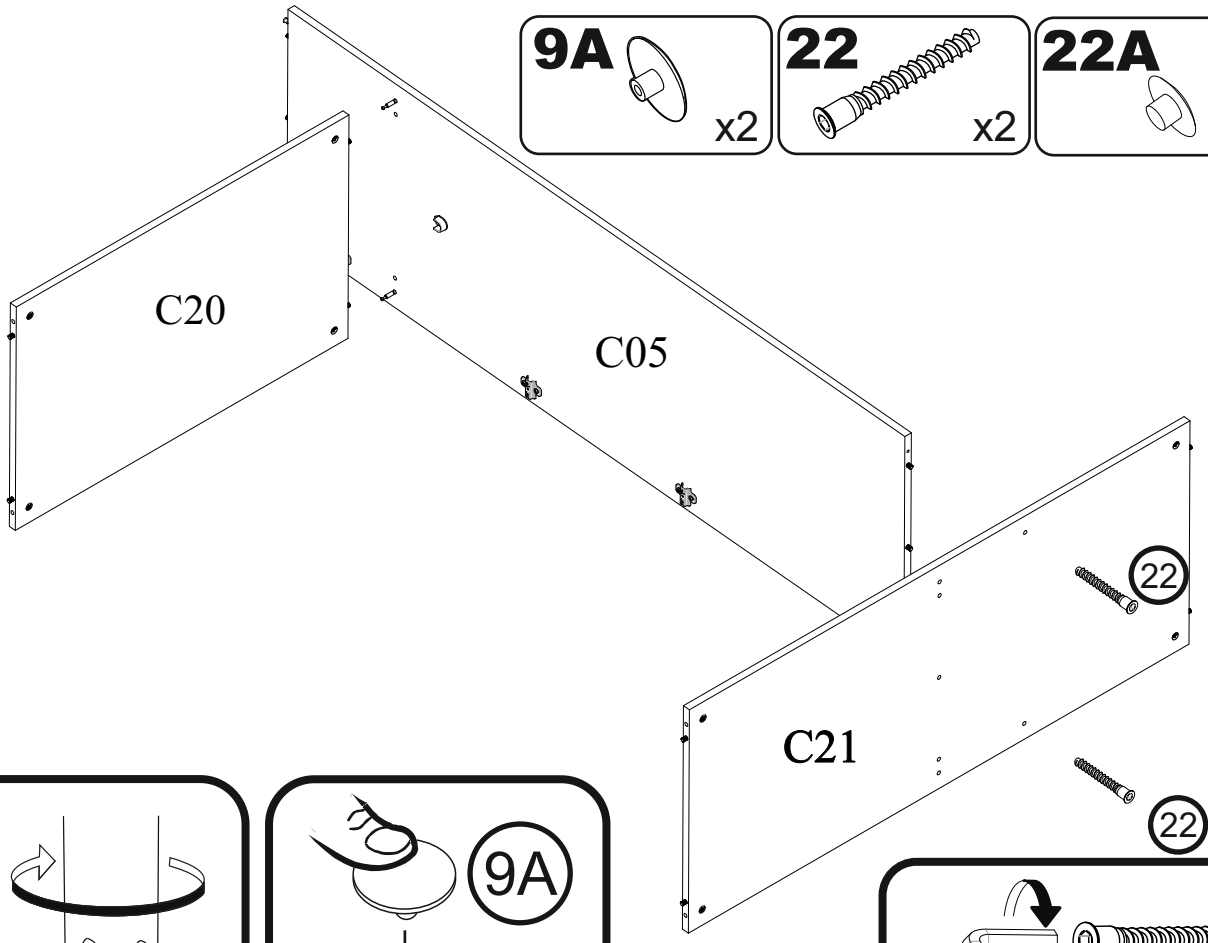
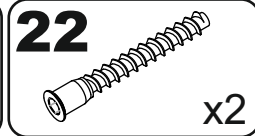
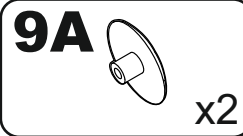

# 13

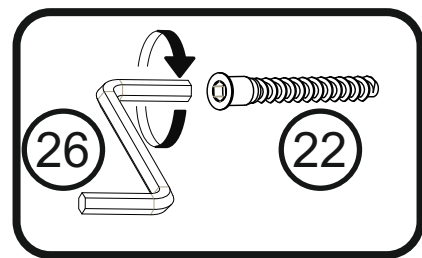
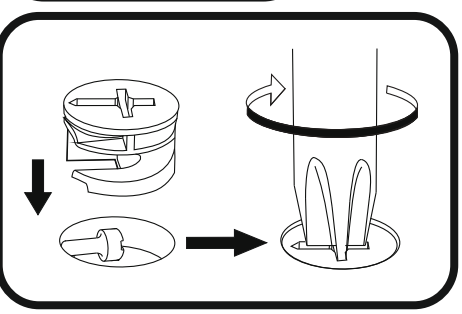
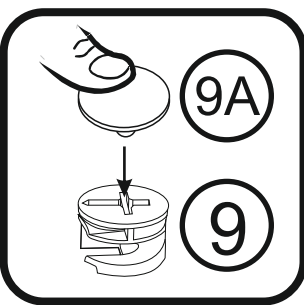
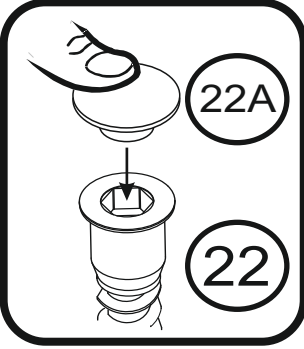
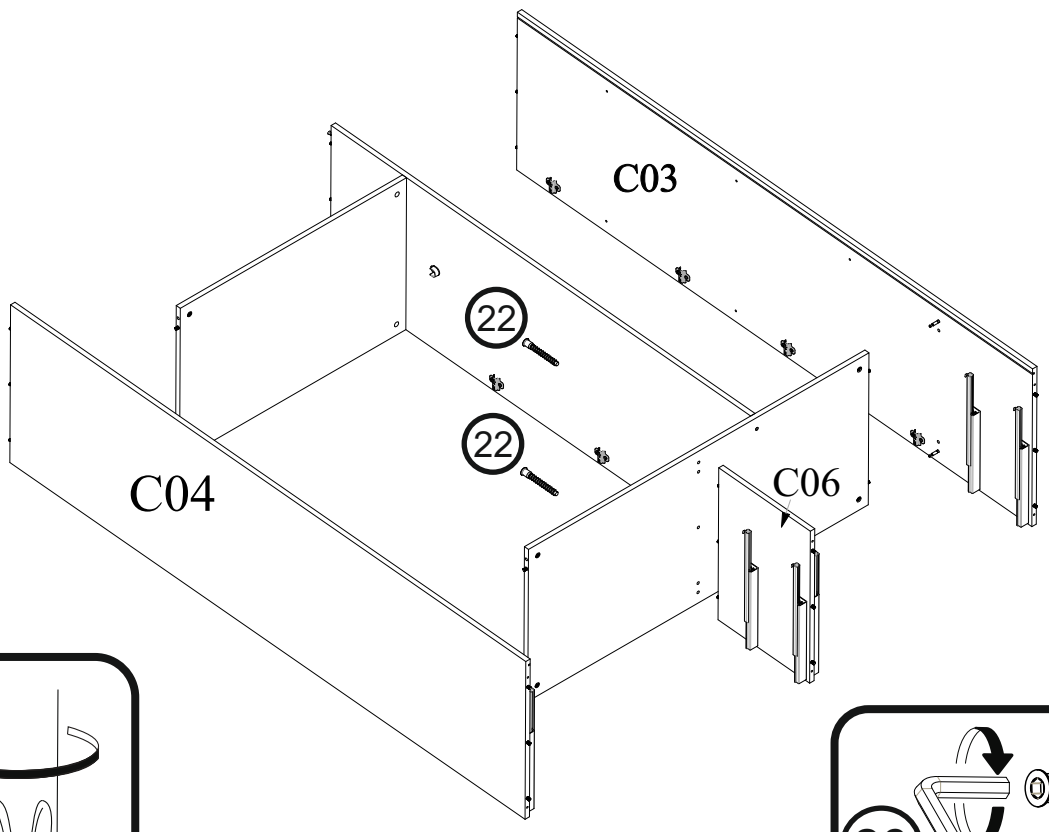
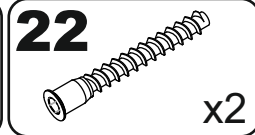

# 14

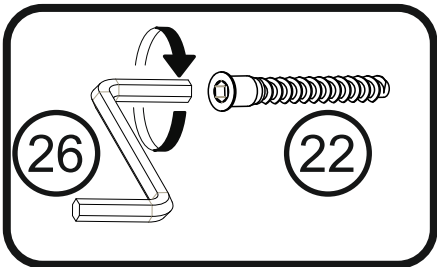
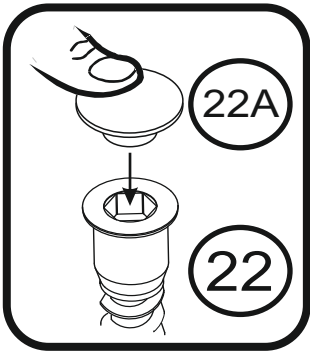
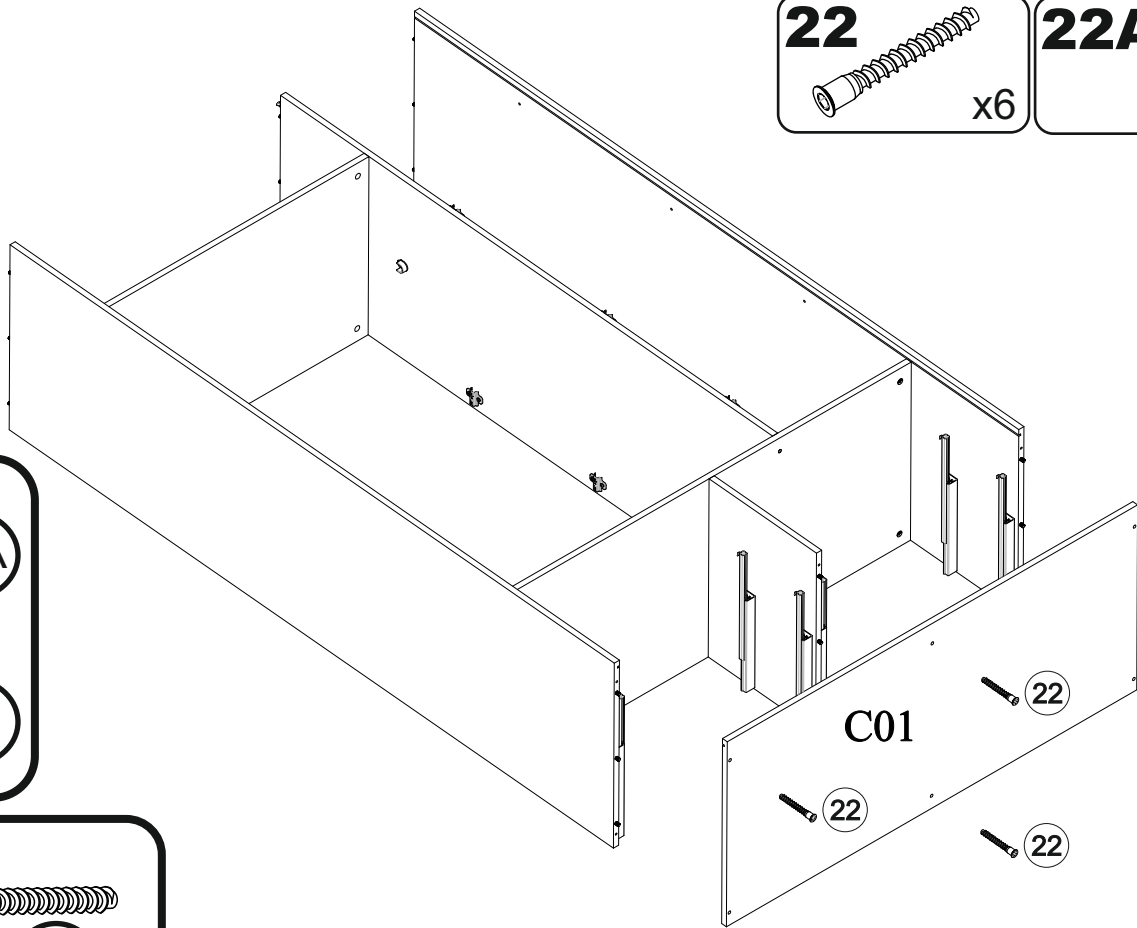
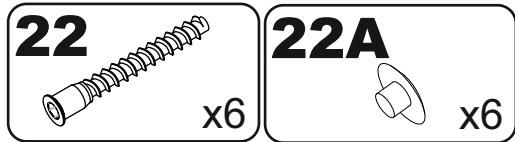

# 15

60

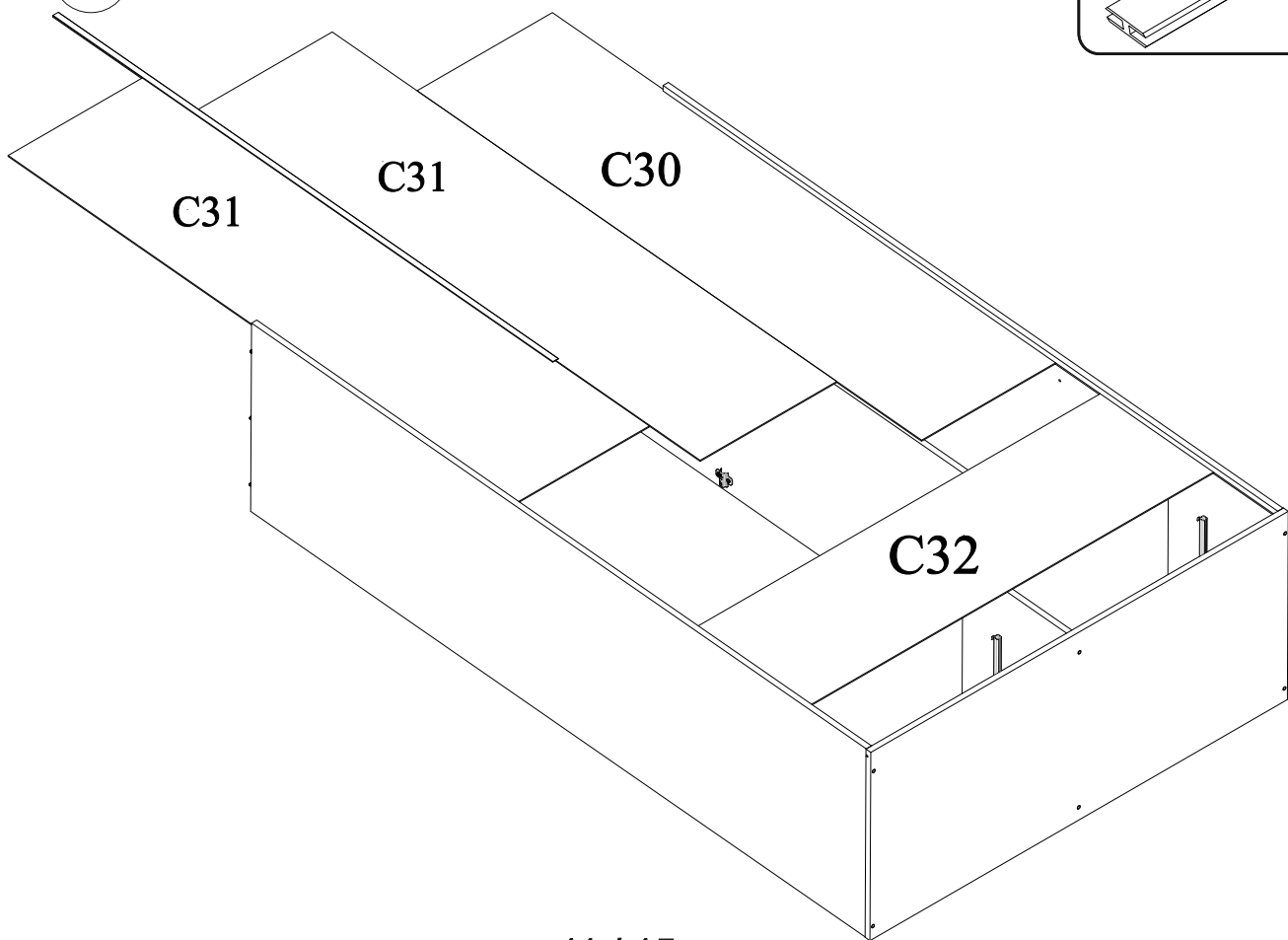
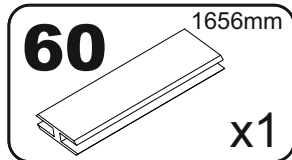

# 16

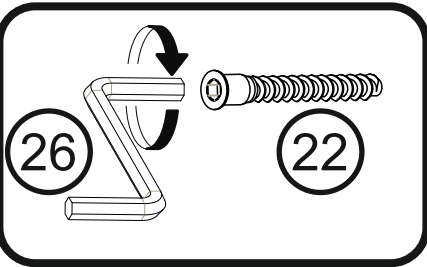
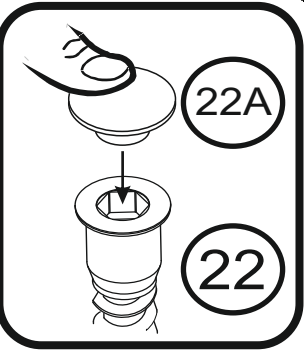
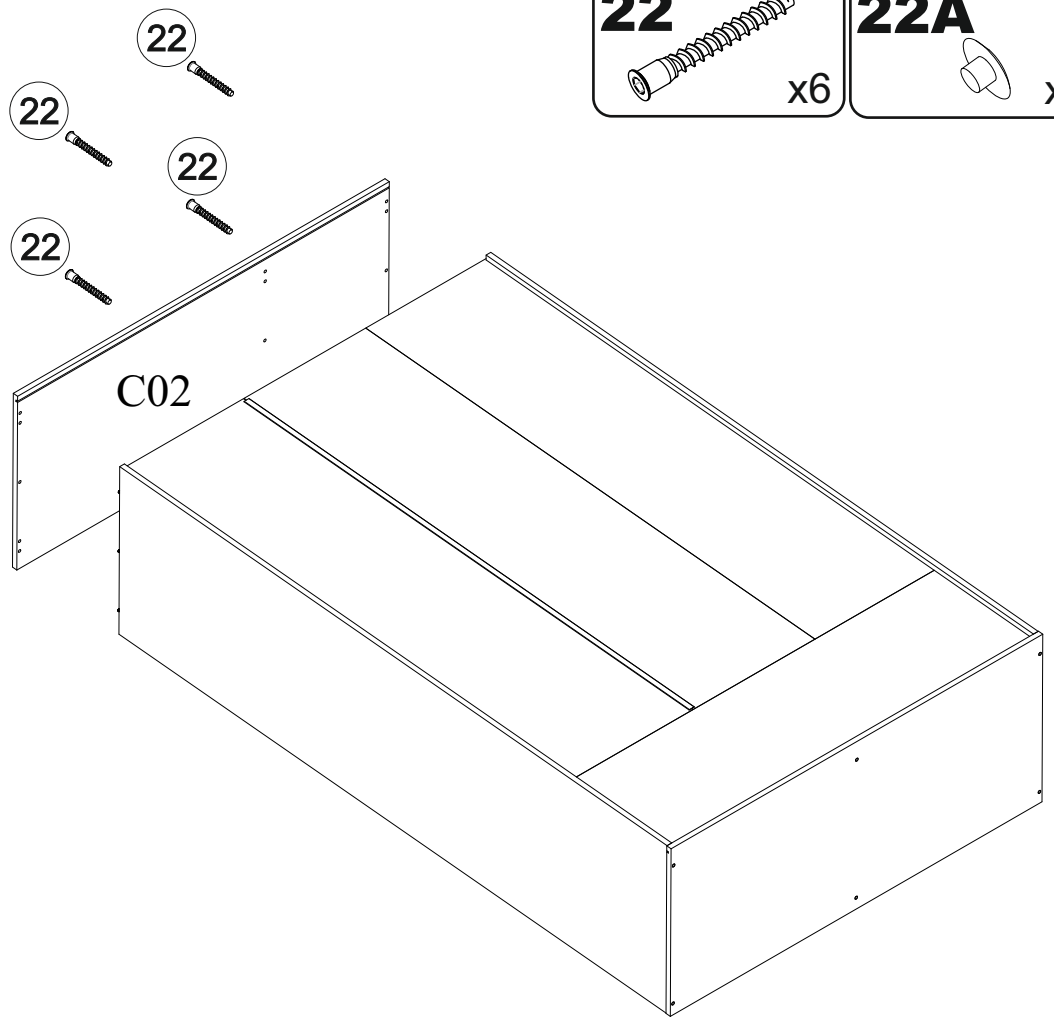
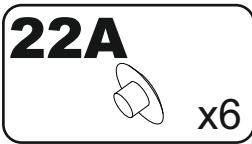
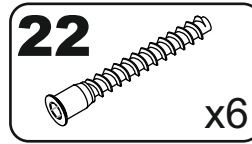

# 17

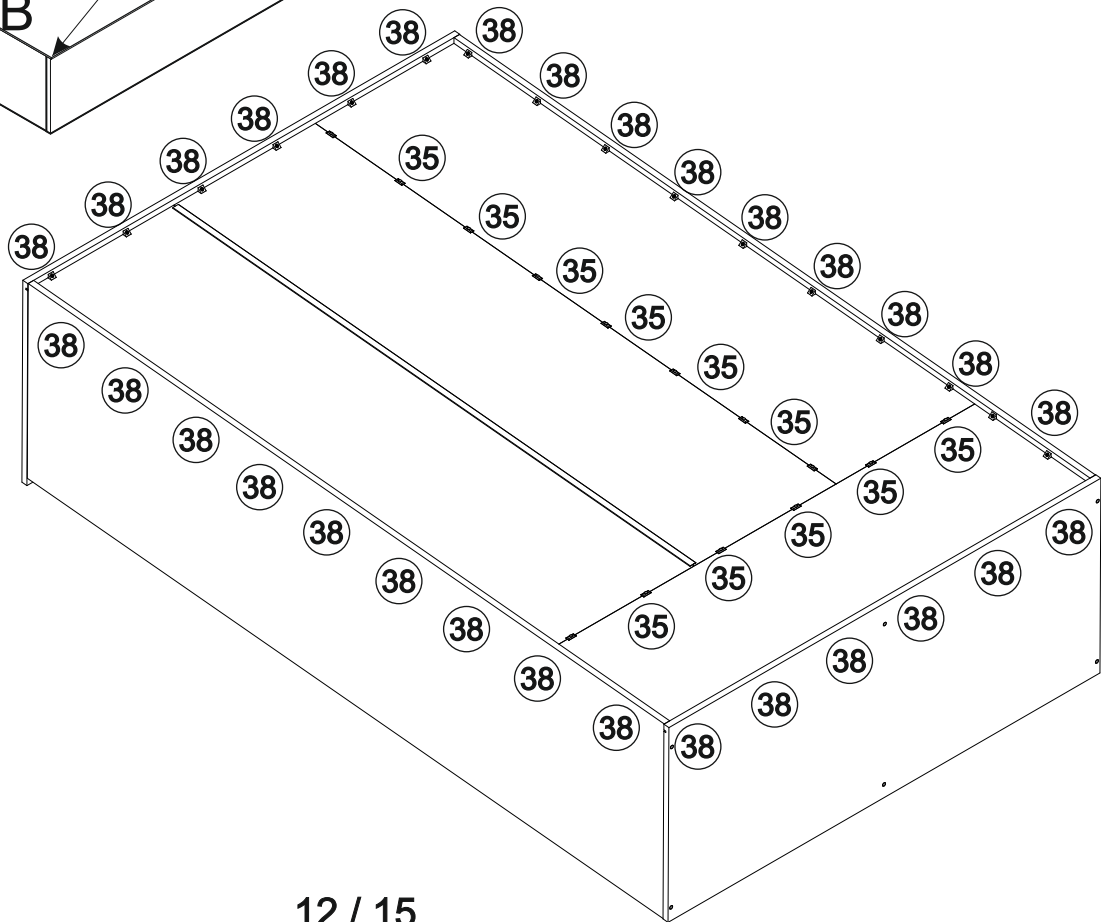
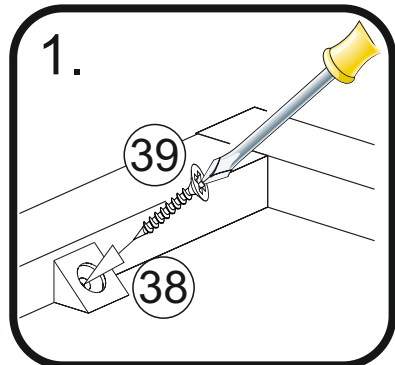
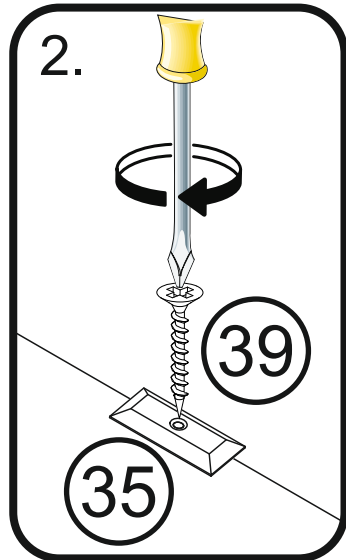
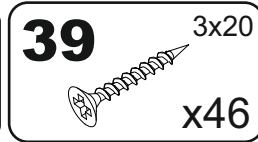
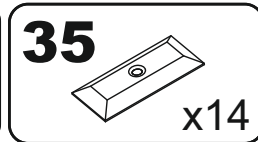
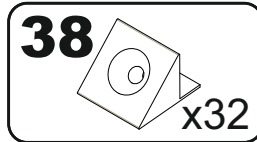
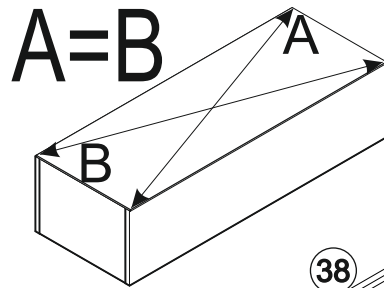

# 18

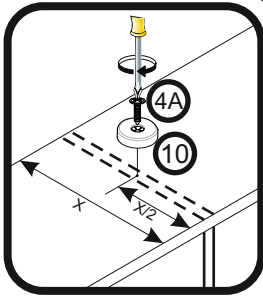
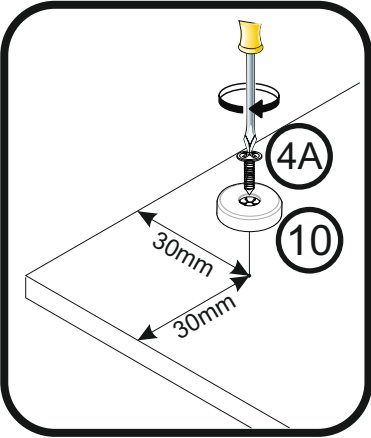
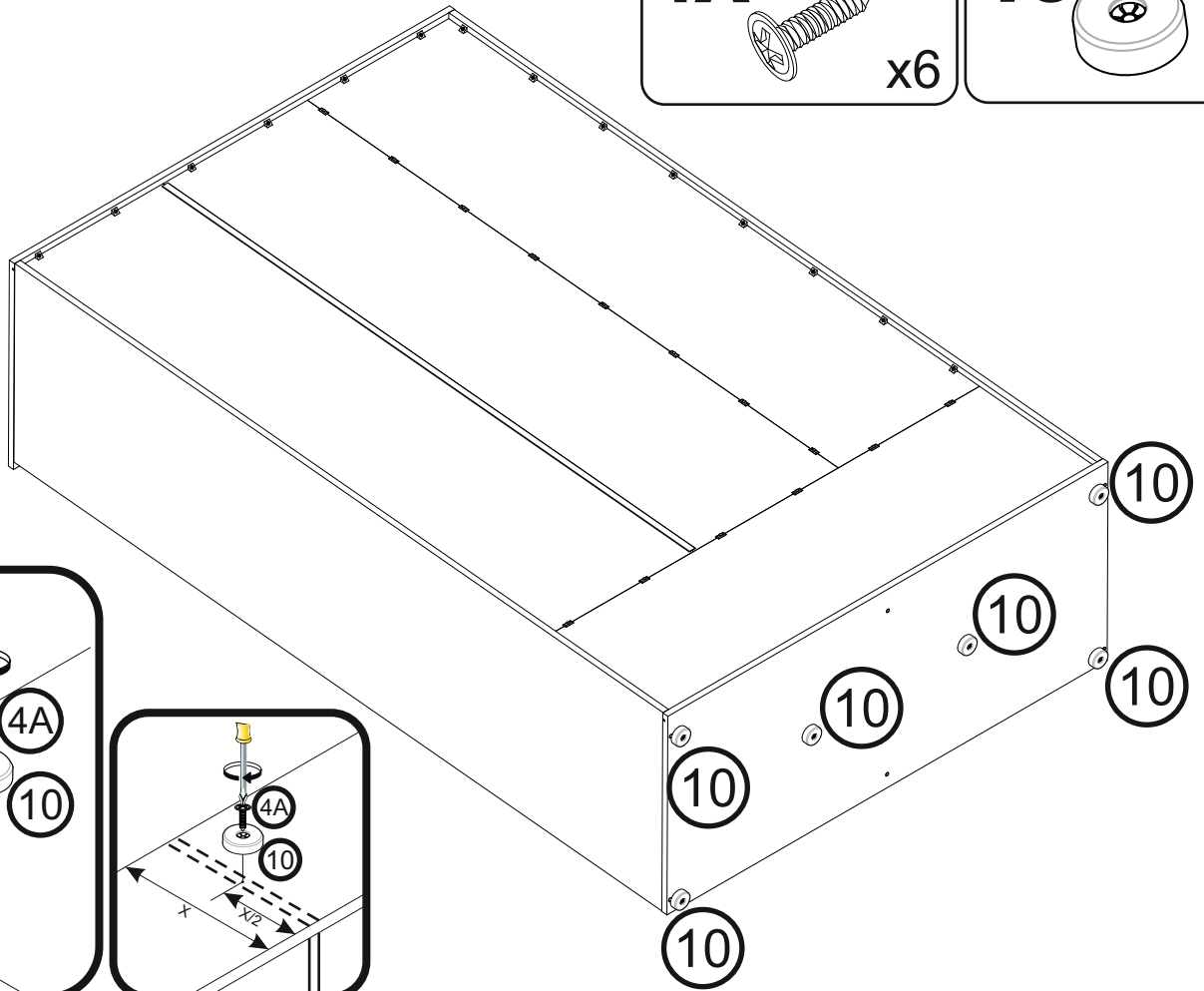
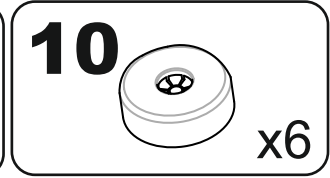
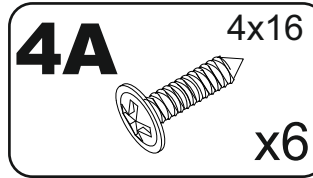

# 19

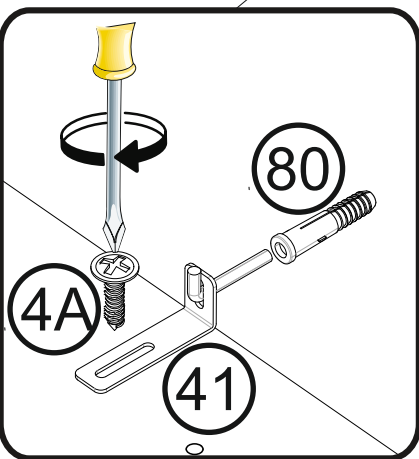
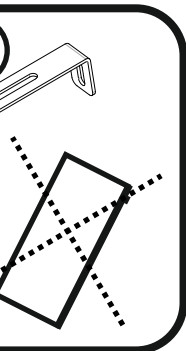
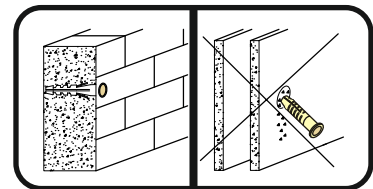
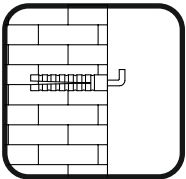
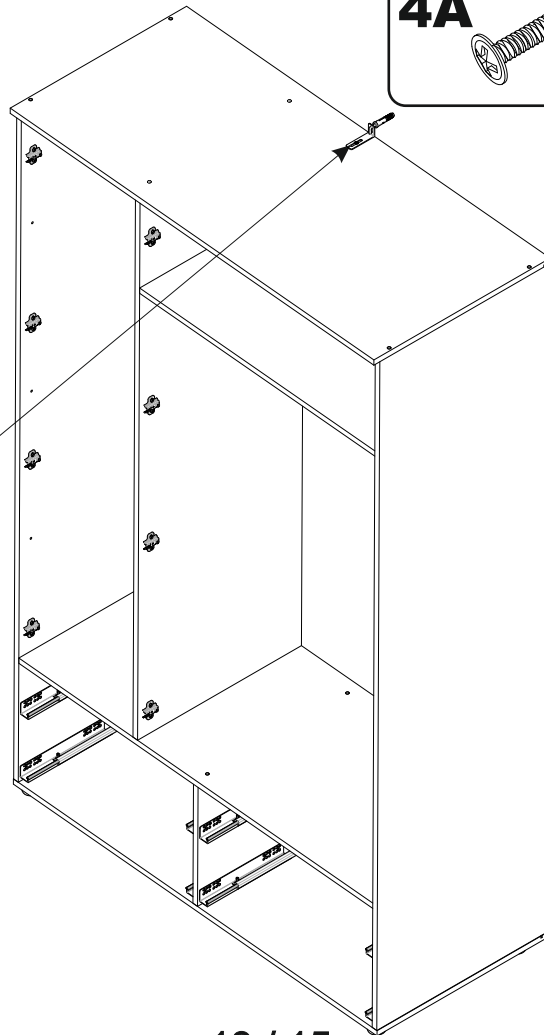
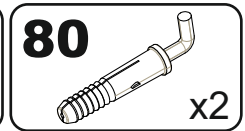
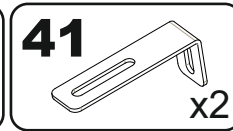
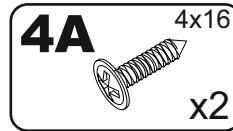



# 20

**93A** 805mm  
x1

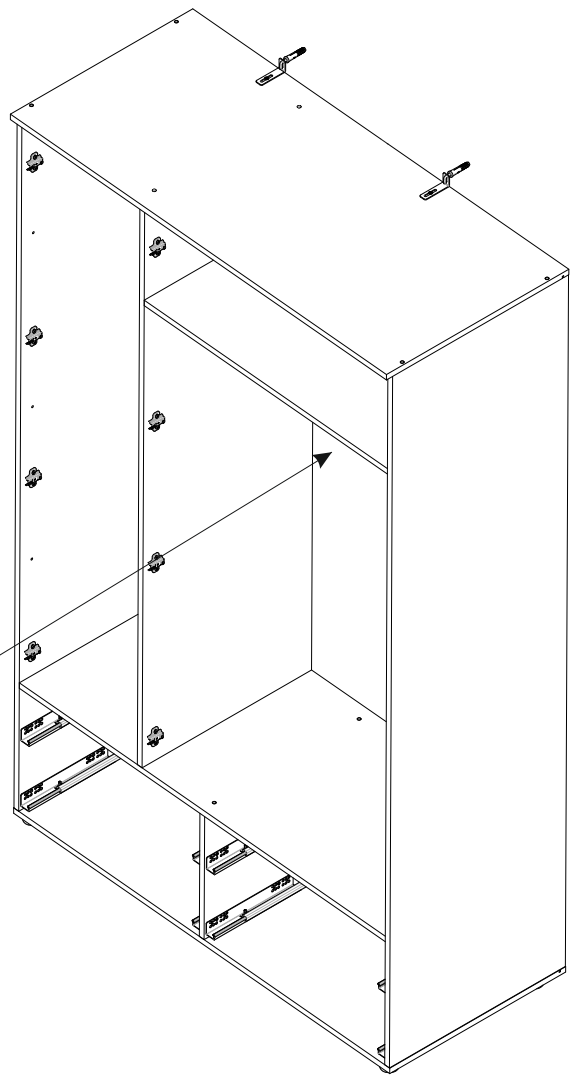
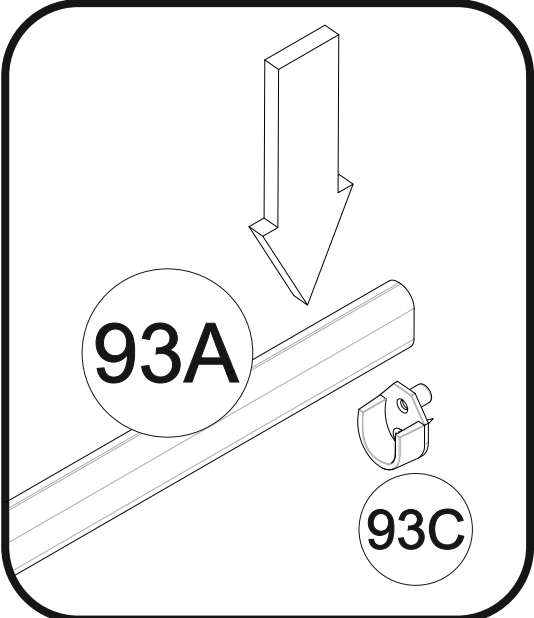

# 21

**13**  
x12

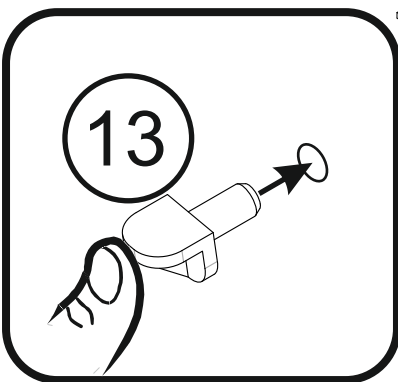
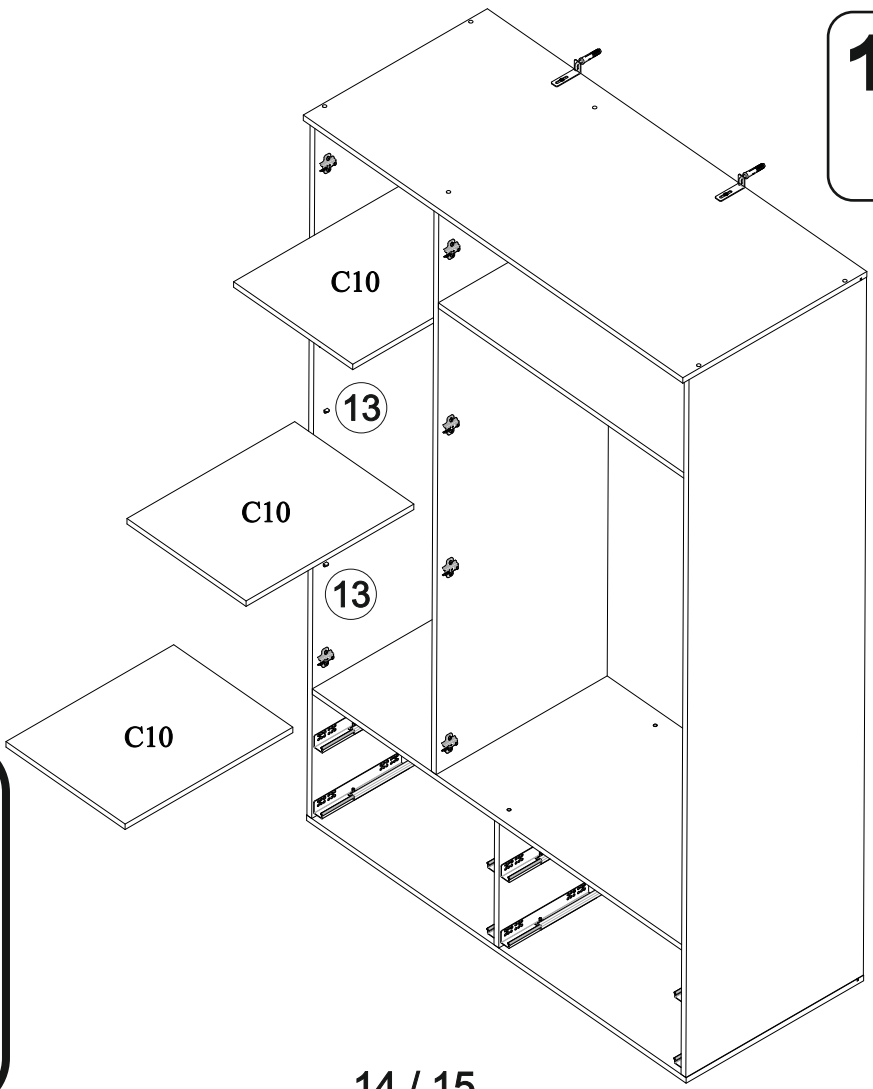

# 22

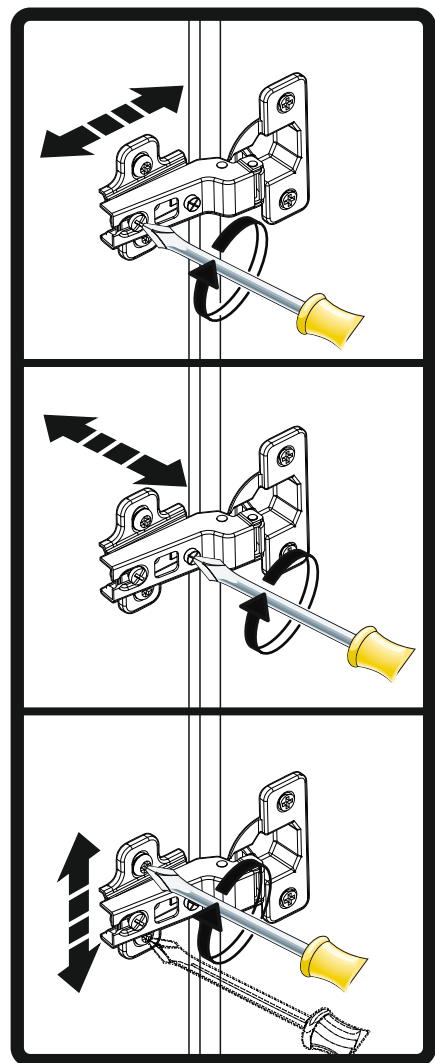
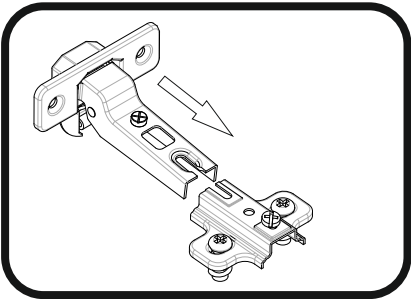
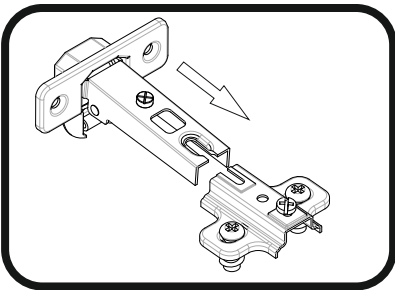
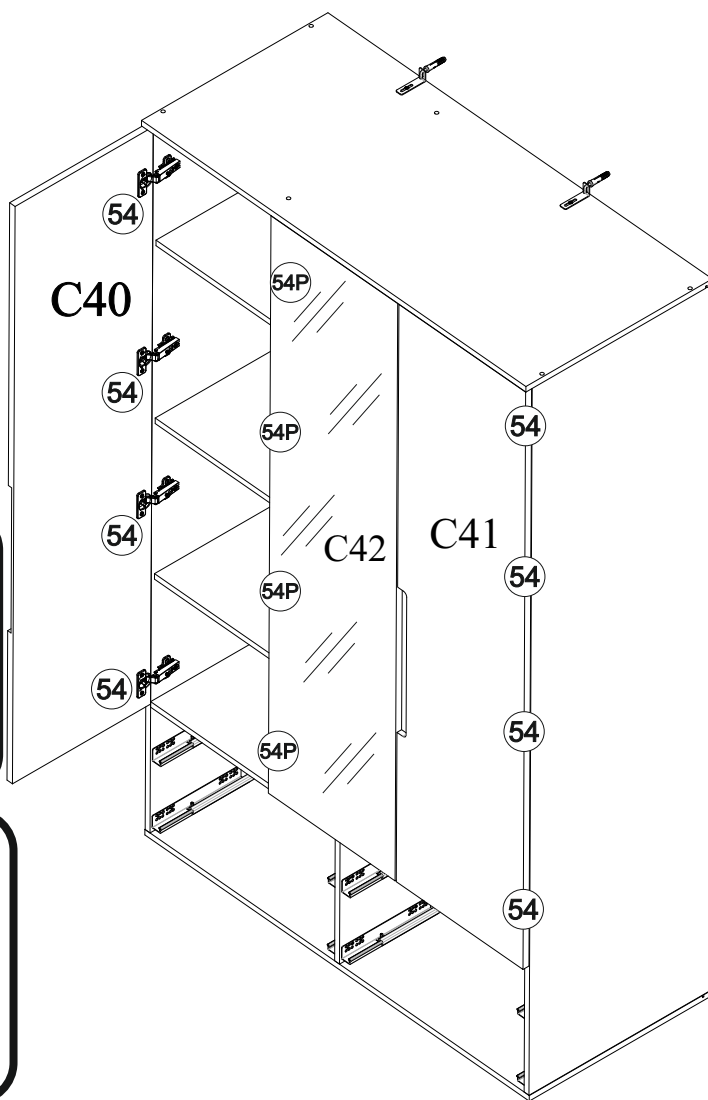

# 23

