



















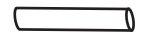

ASSEMBLY INSTRUCTION

Item NO.: Alberto

Item NO.: LCT009

HARDWARE LIST			
NO.	PART	DESCRIPTION	Q'TY
A		top glass	1
B		bottom glass	1
C		steel corner part	4
D		hanger rod	4
E		plastic foot	4
F		foot	4
G		screw	4
H		spring caps	4
I		allen key	1
J		longest rod	4
L		leg	4
M		plastic caps	4
N		metal caps	4
O		small screw nut	4

HARDWARE LIST			
NO.	PART	DESCRIPTION	Q'TY
P		smallest rod	4
Q		smaller rod	4
R		hexagon spanner	1
S		big caps	4
T		big screw nut	4
U		big hexagon spanner	1

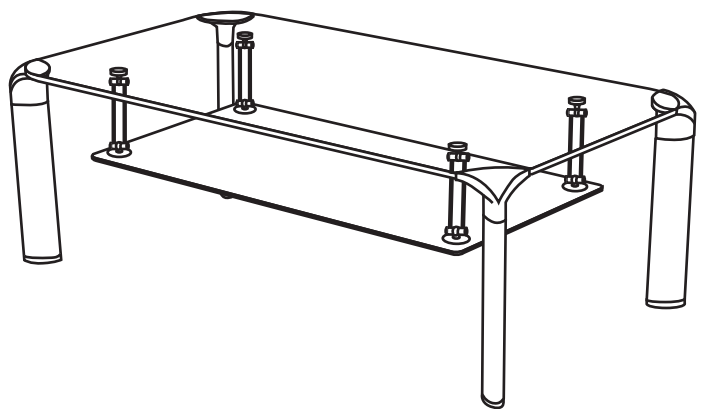

step 1

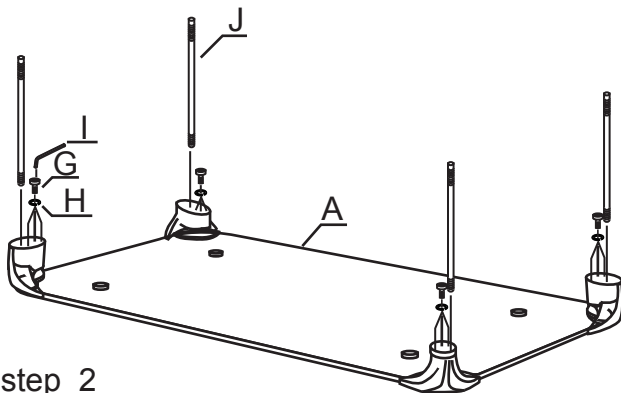

step 3

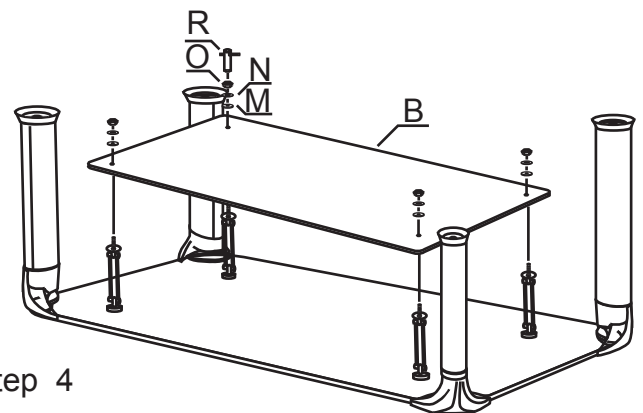

step 2

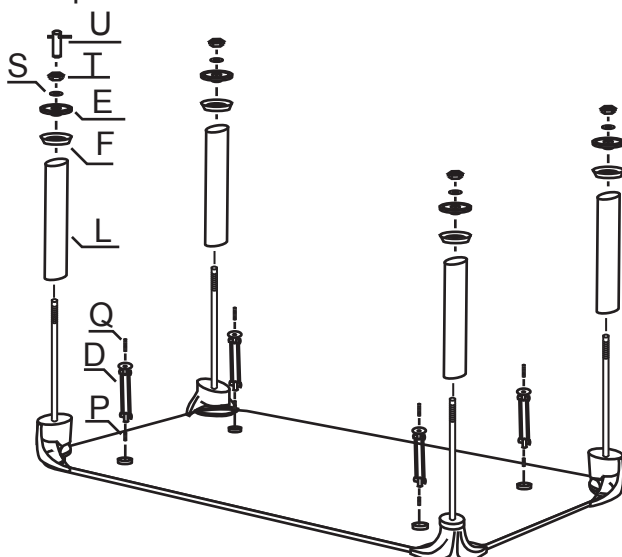

step 4

