

# PASSEPARTOUT 270/225 + LED

PASSEPARTOUT 270/225 + LED 11052015

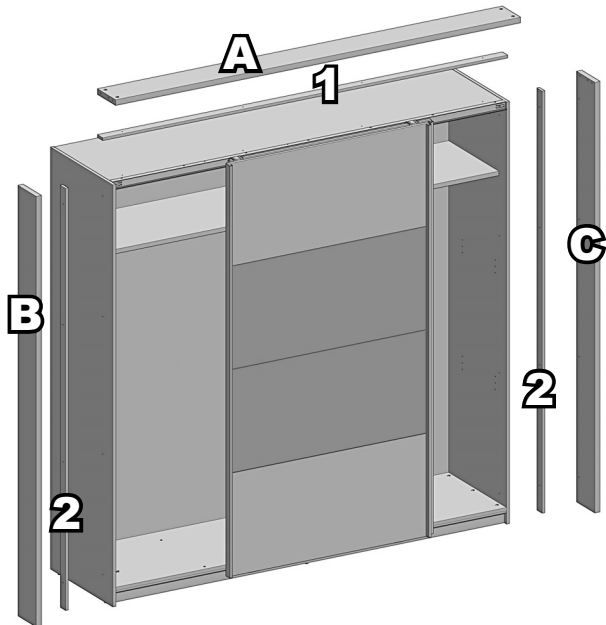

REP	DIM	QTE	package/ colli number
A	2730 x 170 x 28	1	1/1
B	2294 x 172 x 28	1	1/1
C	2294 x 172 x 28	1	1/1
1	2730 x 40 x 15	1	1/1
2	2250 x 40 x 15	2	1/1

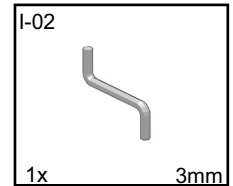
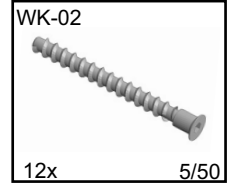
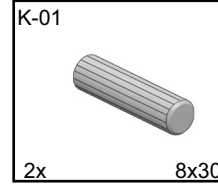
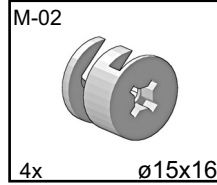
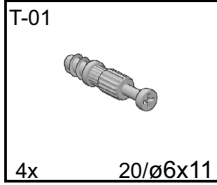
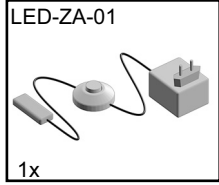
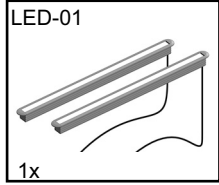
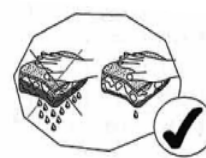
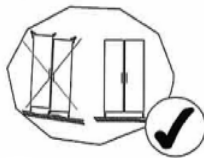
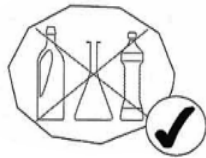
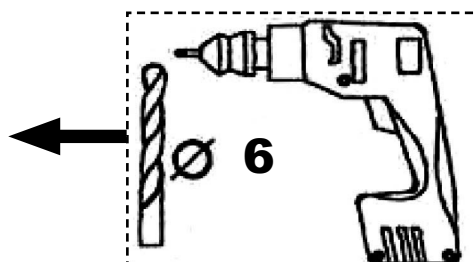
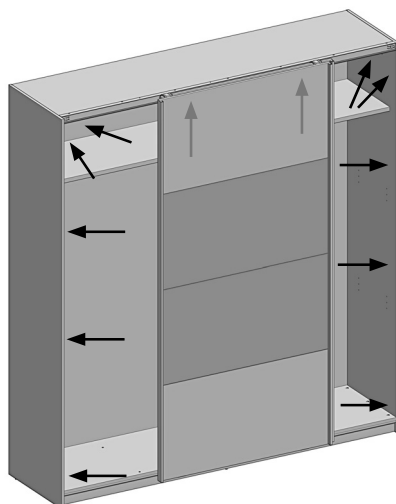
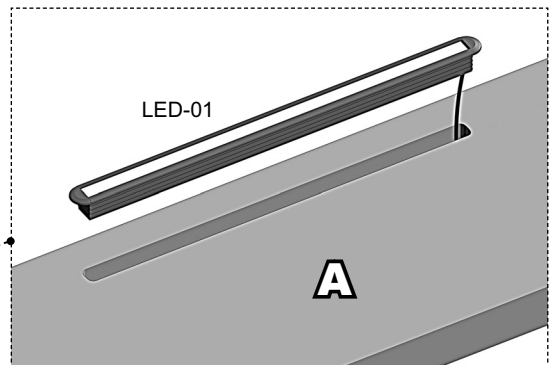
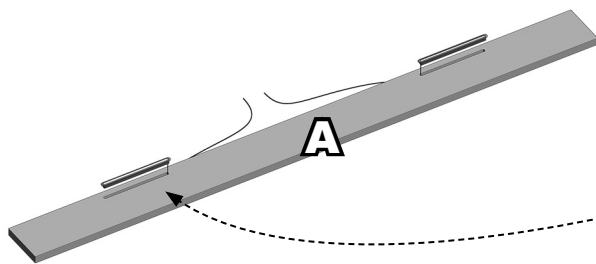

# PASSEPARTOUT 270/225 + LED

PASSEPARTOUT 270/225 + LED 11052015

