

# Sally

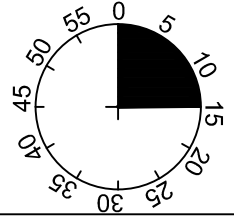

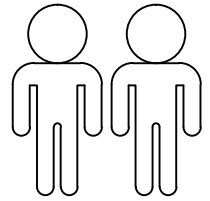

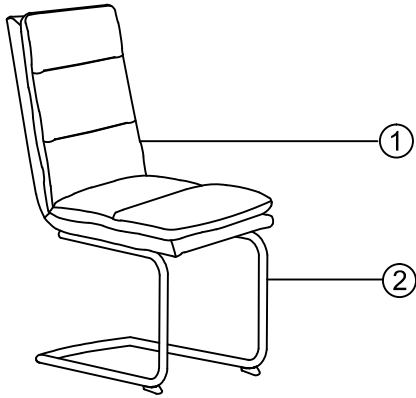
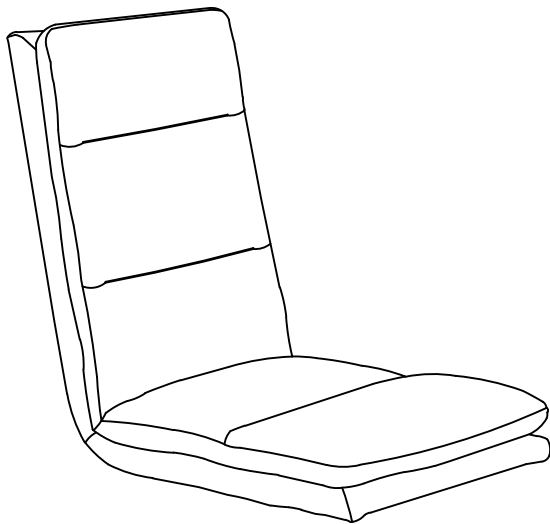

1

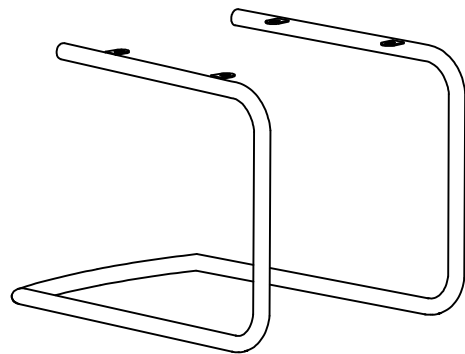

2



1	1x
2	1x

<b>A</b>	M6X20	<b>B</b>	Ø18xØ6x1.5	<b>C</b>	4MM	<b>D</b>	M4X20	<b>E</b>	
									
	4x		4x		1x		4x		2x

**I.**

**1**

D M4x20  
4x

E 2x

100%

**2**

A M6X20  
4x

B Ø18xØ6x1.5  
4x

C 4MM  
1x

75%

**3**

C 4MM  
1x

100%

